

<OrgName>		
Title <Title>		
Size B	Document Number <Doc>	Rev A
Date:	Monday, April 03, 2017	Sheet 1 of 1

H1 ENCODER

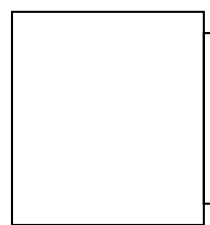

1 GND
2 INDEX
3
4 +5VDC
5

CONNECTORS
NEAR RA
MOTOR

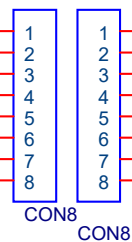

CONNECTORS
ON EAST
SIDE OF RA

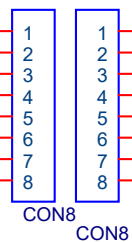

HOLE THRU RA AXIS

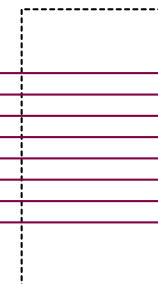

ELECTRONICS BOX

CONNECTORS
AT BOTTOM
OF PIER
EBOX

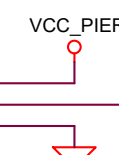
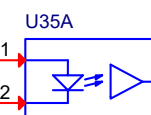
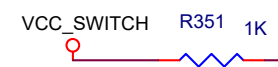
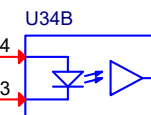
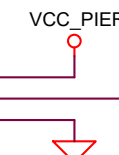
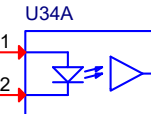
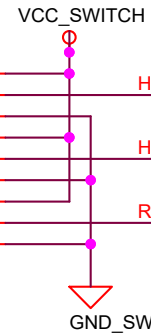
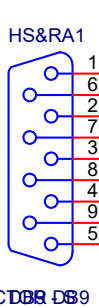
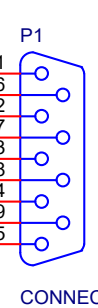
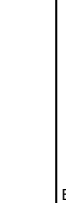
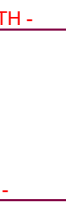
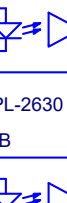
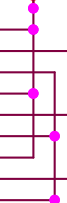
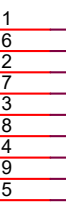
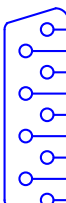
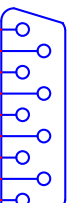
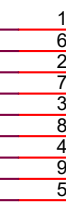
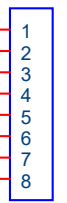

<OrgName>		
Title <Title>		
Size B	Document Number <Doc>	Rev A
Date:	Monday, April 03, 2017	Sheet 1 of 1

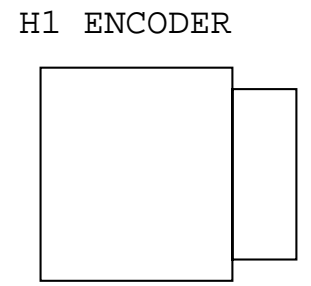
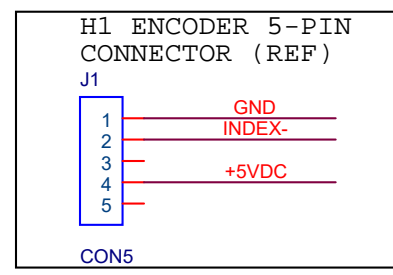

PC4 10-PIN CONECTOR

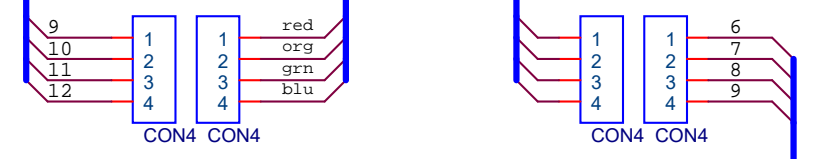
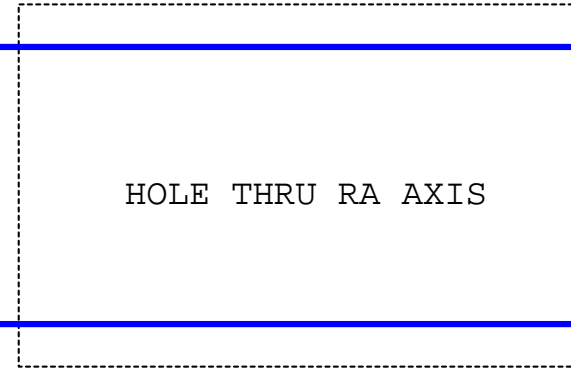
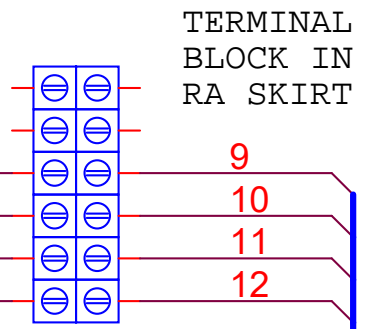
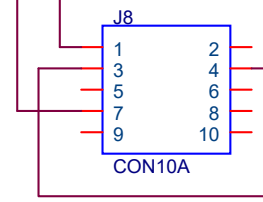

TERMINAL BLOCK AT BOTTOM OF PIER

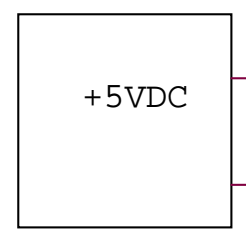
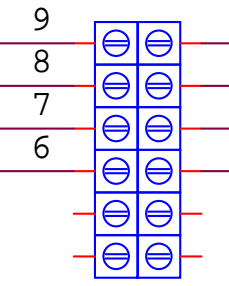

ELECTRONICS BOX

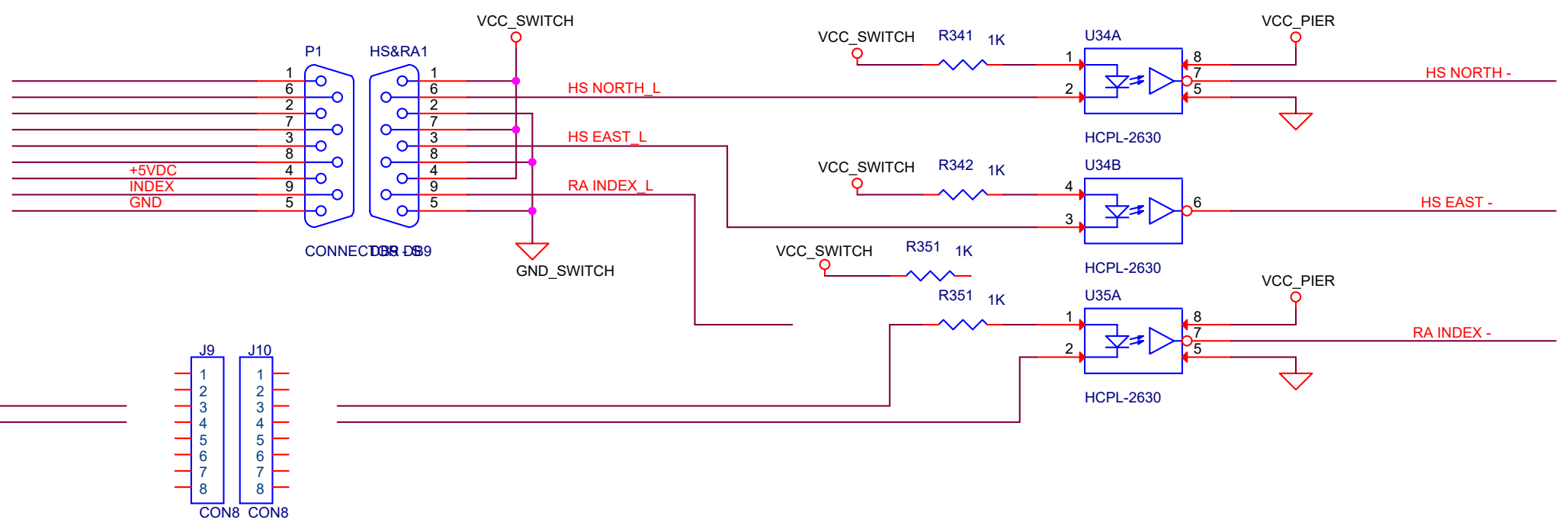

KITT PEAK - SUPERLOTIS TELESCOPE		
Title		
TEMPORARY PEC SENSOR		
Size	Document Number	Rev
B	<Doc>	A
Date:	Monday, April 03, 2017	Sheet 1 of 1