

Mount Graham International Observatory

An Astrophysical Research Site

MOUNT GRAHAM INTERNATIONAL OBSERVATORY (MGIO)

EMERGENCY RESPONSE CONTINGENCY PLAN (ERCP)

& EMERGENCY SITUATIONAL GUIDE

IN AN EMERGENCY:

- 1. EVACUATE TO A SAFE LOCATION**
 - 2. CALL FOR HELP**
 - a. CALL **"MAYDAY"** 3 TIMES OVER RADIO FOR LOCAL RESPONDERS
 - Announce what happened and your location.
 - b. CALL **911** FROM A PHONE FOR OFFSITE PROFESSIONAL RESPONDERS
 - Physical Address of Observatory: 12500 W Swift Trail (State Rt. 366), Safford, AZ
 - 3. ASSIST AS NEEDED, BUT ONLY IF SAFE AND TO YOUR LEVEL OF TRAINING AND EXPERIENCE**
- TURN TO "1.0 STARTING ALGORITHM" FOR SITUATIONAL GUIDE TO EMERGENCIES**

TABLE OF CONTENTS

TABLE OF CONTENTS	2
EXECUTIVE SUMMARY	6
1.0 STARTING ALGORITHM	9
2.0 FIRST AID EMERGENCY	10
2.1 MEDICAL SYMPTOM	11
2.1A ABDOMINAL PAIN	12
2.1B CARDIAC ARREST	13
2.1C CHEST PAIN	14
2.1D DIFFICULTY BREATHING	15
2.1E DIABETIC EMERGENCY	16
2.1F PREGNANCY	17
2.1G SEIZURE	18
2.1H STROKE	19
2.1I UNCONSCIOUS / UNRESPONSIVE	20
2.1J ALTITUDE SICKNESS	21
2.2 TRAUMA INJURY	22
2.2A BACK INJURY	23
2.2B BURNS	24
2.2C BLEEDING / SHOCK	25
2.2D FALL INJURIES & FALL RESCUE	26
2.2E HEAD INJURIES	27
2.2F FRACTURES, SPRAINS, DISLOCATIONS	28
2.2G CRUSH INJURIES	29
2.3 ELECTRICAL INJURY OR ELECTROCUTION	30
2.4 CHEMICAL EXPOSURE	31
2.4a LIQUID NITROGEN EXPOSURE	32
2.4b CHEMICAL EXPOSURE	33
2.5 THERMAL (COLD/HEAT) EXPOSURE	34
2.5A COLD EMERGENCY	35
2.5B HEAT EMERGENCY	36
2.6 TRANSPORT DECISION	37
3.0 COMMUNICATIONS FAILURE	38
4.0 FIRES	39
4.1 STRUCTURE FIRE	40
4.2 FOREST FIRE	41

4.3 EXPLOSION _____	42
4.4 FIRE ALARM GOING OFF _____	43
5.0 CHEMICAL SPILL AND/OR RELEASE _____	44
5.1 LIQUID NITROGEN SPILL AND/OR RELEASE _____	45
6.0 POWER LOSS _____	46
7.0 INCLEMENT WEATHER _____	47
8.0 EVACUATION PROCEDURES _____	48
9.0 SHELTER IN PLACE PROCEDURES _____	49
10.0 WORKPLACE VIOLENCE _____	50
11.0 TRAINING REQUIREMENTS _____	51
12.0 EMERGENCY OPERATIONS CENTER (EOC) _____	52
12.1 EOC ACTIVATION _____	53
12.1A EOC INCIDENT COMMANDER (IC) _____	54
12.1B OPERATIONS CHIEF _____	55
12.1C PLANNING CHIEF _____	56
12.1D LOGISTICS CHIEF _____	57
12.1E FINANCE CHIEF _____	58
12.1F MEDIA AND COMMUNICATIONS CHIEF _____	59
APPENDIX A: CONTACT LISTS _____	61
IC: INCIDENT COMMANDERS _____	61
UNIVERSITY OF ARIZONA RESOURCES _____	62
STATE AND NATIONAL AUTHORITIES _____	64
EMERGENCY SERVICES AND OTHER AGENCY RESOURCES _____	65
AUTHORIZATION OF INCIDENT COMMANDERS _____	66
APPENDIX B: REPORTING REQUIREMENTS _____	67
APPENDIX C: EQUIPMENT _____	68
MGIO Emergency Evacuation Vehicle _____	68
Automatic External Defibrillators (AED) _____	69
LBT Equipment Locations _____	69
VATT Equipment Locations _____	69
SMT Equipment Locations _____	70

Utility Building Equipment Locations _____	70
UAPD Building Equipment Locations _____	70
Base Camp Equipment Locations _____	70
VEHICLE EQUIPMENT ASSIGNMENTS _____	71
FIRE, SPILL, FIRST AID TRANSFER AND HIKE OUT GEAR PACKS _____	72
APPENDIX D: COMMUNICATIONS SYSTEMS _____	76
VOICE & DATA COMMUNICATIONS _____	76
MGIO RADIO SYSTEM _____	78
VHF RADIO FREQUENCIES USED BY THE OBSERVATORY _____	79
APPENDIX E: SITE MAPS & SCHEMATICS _____	80
Exhibit 9: Swift Trail Reference Road Markers _____	81
Exhibit 10: Map of Southeastern Arizona _____	82
Exhibit 11: Map of Pinaleno Mountains/Swift Trail _____	84
Exhibit 12: MGIO Location/Site Plan _____	85
Exhibit 13: MGIO Research Site Boundary _____	87
Exhibit 14: MGIO Site Plan w/Building Numbers _____	89
Exhibit 15: MGIO Utility Building, Water, and Propane Layouts _____	90
Exhibit 16: MGIO Power Distribution System _____	92
Exhibit 17: MGIO Propane Distribution System _____	93
Exhibit 18: MGIO Water and Fire Protection Water Dist. Systems _____	94
Exhibit 19: MGIO Diesel Fuel Transfer System _____	95
Exhibit 20: Mt. Graham Regional Medical Center Location Map _____	96
Exhibit 21: Helicopter Landing Map _____	98
Exhibit 22: Building Evacuation Assembly Area Map _____	100
APPENDIX F: PERIODIC REVIEW, MAINTENANCE AND TESTING REQUIREMENTS _____	102
APPENDIX G: ERT GUIDELINES _____	104
Emergency Response Team (ERT) Overview _____	104
Duty for Each Organization to Participate _____	104
ERT Training & Drills _____	104

The Multi-Building Approach _____	104
Head Count/Roll Call (Who is on site) _____	104
Post-Incident Debriefing/Lessons Learned _____	105
APPENDIX H: 911/EMS (EMERGENCY MEDICAL SYSTEM) CALLING GUIDELINES _____	106
Further Guidance _____	106
Calling for help from MGIO _____	106
Speaking With Emergency Medical Services (EMS) _____	107
Meeting Emergency Services off-Summit _____	107
What to Expect on the Call _____	108
Immediate Caller Duties _____	108
APPENDIX I: STRUCTURE AND FOREST FIRE GUIDELINES _____	109
Building Fire Alarm Systems _____	109
Evacuation Due to Fire Alarm and False Alarms _____	109
Fire Prevention and Suppression Guidelines _____	110
UAPD MGIO FIRE ALARM NOTIFICATION CALL TREES _____	113
APPENDIX J: HAZARDOUS MATERIALS/SPILL RESPONSE GUIDELINES _____	114
Hazard Assessment & Determinations Guidelines _____	114
Evacuation and Notifications _____	114
Site Layout _____	114
Prevention Measures _____	115
Chemicals on Site _____	115
Safety Data Sheets (SDS; formally Material Safety Data Sheets) _____	118
Reportable Quantity Requirements for Chemical Spills _____	120
Fuel and Lubricant Transport, Consumption and Storage Requirements _____	122
Liquid Nitrogen Transport DOT/CDL Exemptions _____	123
APPENDIX K: ACTIVATING THE ERCP (GUIDELINES) _____	134
When to Contact an Incident Commander (GUIDANCE) _____	134
Events Leading to Implementation of the Contingency Plan _____	134
APPENDIX L: INCIDENT ACTION PLAN (IAP) GUIDELINES _____	136

EXECUTIVE SUMMARY

The information contained herein is submitted in accordance with the requirements for an Emergency Response and First Aid Plan, Chemical Waste Management Plan, Spill Control and Countermeasures Plan (SPCC Plan), and a Fire Response Plan, as contained in the U.S. Forest Service Special Use Permit and Management Plan for the Mt. Graham International Observatory. These plans are set forth in this document, called the *Emergency Response Contingency Plan*, also referred to as the Contingency Plan, or ERCP. A copy of the Contingency Plan is available on the MGIO website (mgio.arizona.edu), in the LBTO VCAN document system and in binders at Base Camp, the Observatory site, and at the University of Arizona Police Department (UAPD) and at the Risk Management Services (RMS) department along with strict operating and safety directives. Copies of this plan have also been provided to the U.S. Forest Service, Graham County Sheriff's Office, Lifeline Ambulance, Safford, Thatcher, and Pima Fire Departments, and the Department of Public Safety – Air Rescue Branch, Tucson.

This Contingency Plan has been developed for the University of Arizona's Mt. Graham International Observatory (MGIO), located on an 8.6 acre area near Emerald Peak; a 10,500' summit in the Pinaleno Mountains of southeast Arizona, a part of the Coronado National Forest, near Safford, Arizona. This facility consists of:

- The Vatican Advanced Technology Telescope (VATT)
- The Heinrich Hertz Submillimeter Telescope (SMT)
- The Large Binocular Telescope Observatory (LBTO)
- Summit Utilities Building
- UAPD Building
- Base Camp
- Access Road
- Electrical power distribution boxes (throughout the mountain)

A Base Camp is located at the base of the Mount Graham approximately six miles south of Safford Arizona on State Route 366 (aka Swift Trail) at 1480 W. Swift Trail Safford, AZ 85546. Base Camp is located on Bureau of Land Management (BLM)-owned land. The site is managed by the Department of Justice, Bureau of Prisons. It is located across the street from Federal Correctional Institute (FCI) Safford. The University also owns and operates 14 acres located at 1830 W. SR366, Safford, AZ 85546. This location will become the new MGIO base camp sometime in the future. The address of the observatory (LBTO, VATT, SMT, Summit Utilities Building, and UAPD Building) is 12500 W Swift Trail (State Rt. 366), Safford, AZ.

The University is a land-grant educational institution controlled by the Arizona Board of Regents for the State of Arizona. The primary purpose of the Observatories is to provide a remote site in which to conduct astrophysical research.

Maps indicating the location of the MGIO in the context of Southeastern Arizona, the Pinaleno Mountains, the area surrounding the Observatory, and the Observatory site are contained in [Appendix E](#), along with road milepost markers and schematic diagrams of on-site utility systems. Maps of the helicopter landing areas and Mt. Graham Regional Medical Center can be found in Appendix E, as well.

This contingency plan will be implemented in any of the following situations:

- **Medical:** A medical emergency requiring: medical care beyond basic first aid, an outside agency Emergency Medical Services (EMS) response, and/or a medical evacuation.
- **Communications Failure:** A failure of the communications system.
- **Fires:** A structural fire that cannot be immediately extinguished with available extinguishers, an explosion, or any forest fire that threatens the Observatory requiring an evacuation.
- **Large Chemical Spill and/or Release:** A spill that cannot be contained and/or cleaned up with available equipment. Any large cryogenic release.
- **Power Loss:** A commercial power loss that also involves back-up generator failure.
- **Inclement Weather:** Inclement weather that traps staff at the Observatory or requires an evacuation.

The University of Arizona is only responsible for emergency situations or chemical spills caused by its employees or their visitors/contractors. This Contingency Plan does not address situations that are the responsibility of others.

The goals of this contingency plan, in order of importance, are:

1. Provide for life safety
2. Conserve property
3. Limit environmental impact
4. Return the Observatory to full operation

At least 3 Emergency Response Team (ERT) members trained in first aid should be on summit. This meets OSHA 1910.151 which requires employees to be trained in first aid to assist during medical incidents for remote facilities without a medical clinic. The **Emergency Response Team (ERT)** is comprised of UA staff available to respond to emergency situations per their level of training (see [Section 11.0](#)), comfort and ability. ERT members are not medical providers, and they are not trained as such. Detail on the ERT and how it is structured at MGIO can be found in [Appendix G](#). During an emergency, ERT members will likely be the first on the scene. The first ERT member on the scene may become the temporary **Incident Commander (IC)** until an emergency coordinator is called from [Appendix A](#), at which time they will relinquish their duty of IC, and the emergency coordinator will take over as IC. ERT must use their training and expert opinion as to when to contact an IC, but they should always make the call if there is any

doubt. The people listed in Appendix A “Incident Commanders” are available 24-hrs., and they can be reached directly by phone or via UAPD dispatch. Once activated, the IC will determine to what capacity an **Emergency Operations Center (EOC)** is required per [Section 12.0](#). This section also outlines the duties of the IC and other chief officers.

This document is structured using **algorithms**, which are meant to provide quick, logical guidance to ERT staff during an emergency. Some topics warrant supplemental information, in which case the information will be referenced in the appendices (e.g. fires, hazardous materials, ERT operations, 911 activation, etc.). This document is meant to be used in conjunction with proper training and experience and is not meant to provide step-by-step instructions to untrained individuals.

This Emergency Response Contingency Plan will be reviewed annually including a formal exercise/drill that tests the Senior Staff, the Emergency Operations Center (EOC), and at least one section of this Emergency Response Contingency Plan. A table of items requiring review or service, along with their periodicity and responsible parties, are included in [Appendix F](#). It is ultimately the responsibility of MGIO and Observatory Management to ensure periodic maintenance and test activities are completed.

Some incidents require reporting to University, law enforcement, regulatory, or government agencies. Refer to [Appendix B](#) for reporting requirements. It is the responsibility of MGIO and Observatory Management to ensure reporting is thoroughly completed in a timely manner.

References:

UA Spill Prevention Control & Countermeasures (SPCC) Plan

S100s00100 USDA-FS Special Use Permit SAF2035-01- UA,STEWARD

All medical, trauma, and environmental algorithms will be consistent with American Heart Association’s First Aid Guidelines which can be viewed

at:<https://eccguidelines.heart.org/index.php/circulation/aha-red-cross-first-aid-guidelines/>

Revision History

Issue	Date	Changes	Responsible
10	7/24/2012	Unknown. Updated 2/6/2013	Eric Buckley
a	01-Apr-2019	Document re-write to include situational algorithms for a number of risks identified in 2018 Risk Assessment as well as more details on emergency equipment and communications systems. Contributors and Reviewers: David Carroll (LBTO), Ray Klein (HPI), Eric Buckley (MGIO), Wade Boltinghouse (UAPD), Paul Gabor (VO), Alyson Ford (ARO), Steve Holland (UA RMS), Chris Williams (AEMRC), Steve Holland (UA-RMS).	David Carroll Eric Buckley

1.0 STARTING ALGORITHM

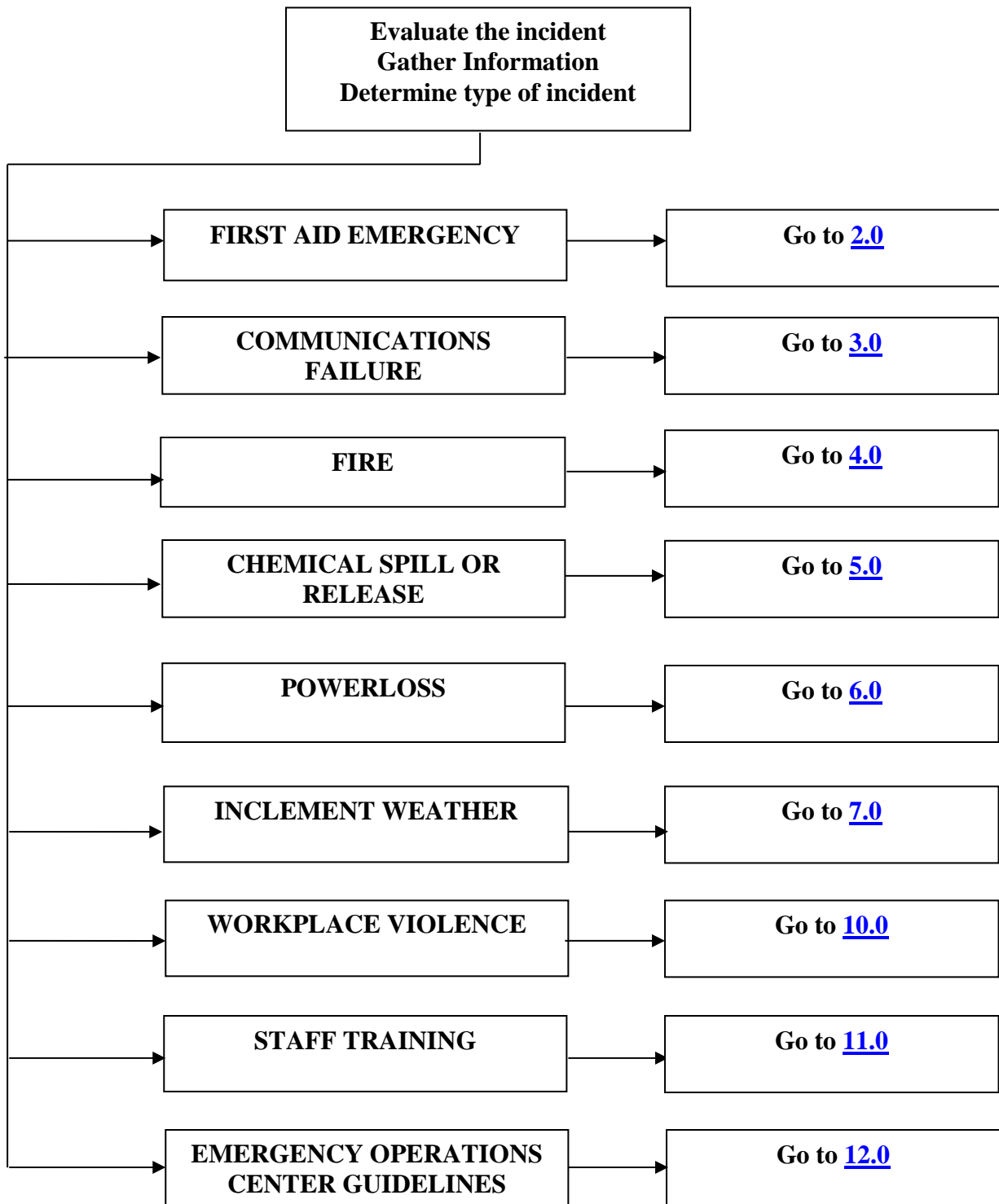

2.0 FIRST AID EMERGENCY

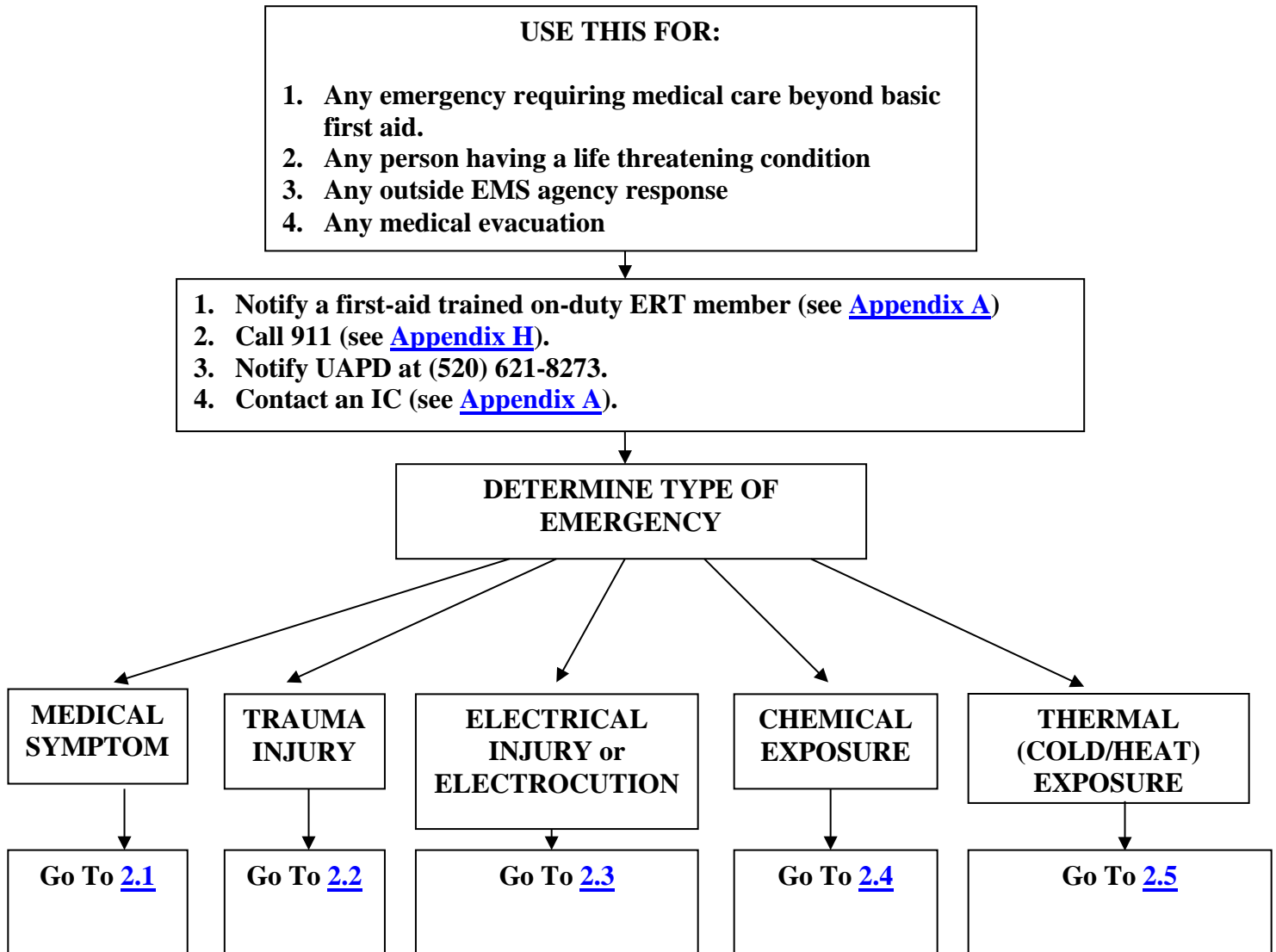

NORMAL PULSE, BLOOD PRESSURE, OXYGEN, AND GLUCOSE RANGES AT MGIO SUMMIT ALTITUDE. IF BELOW, SEEK MEDICAL HELP.

Age	Heart Rate	Systolic BP	Diastolic BP	%O2	Glucose
Adult	60-110 bpm	90-140 mmHg	60-90 mmHg	>80%	>70 mg/dL
1-8 yrs.	80-100 bpm	80-110 mmHg	"	"	"
1-12 mo.	100-120 bpm	70-95 mmHg	"	"	"
1-28 days.	120-160 bpm	>60 mmHg	"	"	"

Note: Systolic BP=top number in reading; Diastolic BP=bottom number in reading

2.1 MEDICAL SYMPTOM

USE THIS FOR:
For any person that has a medical symptom

ERT WILL GATHER APPROPRIATE EQUIPMENT

1. EMS Jump-bag
2. AED

FOR LOCATION OF EQUIPMENT SEE [APPENDIX C](#)

ASSESS THE PATIENT
Determine chief complaint

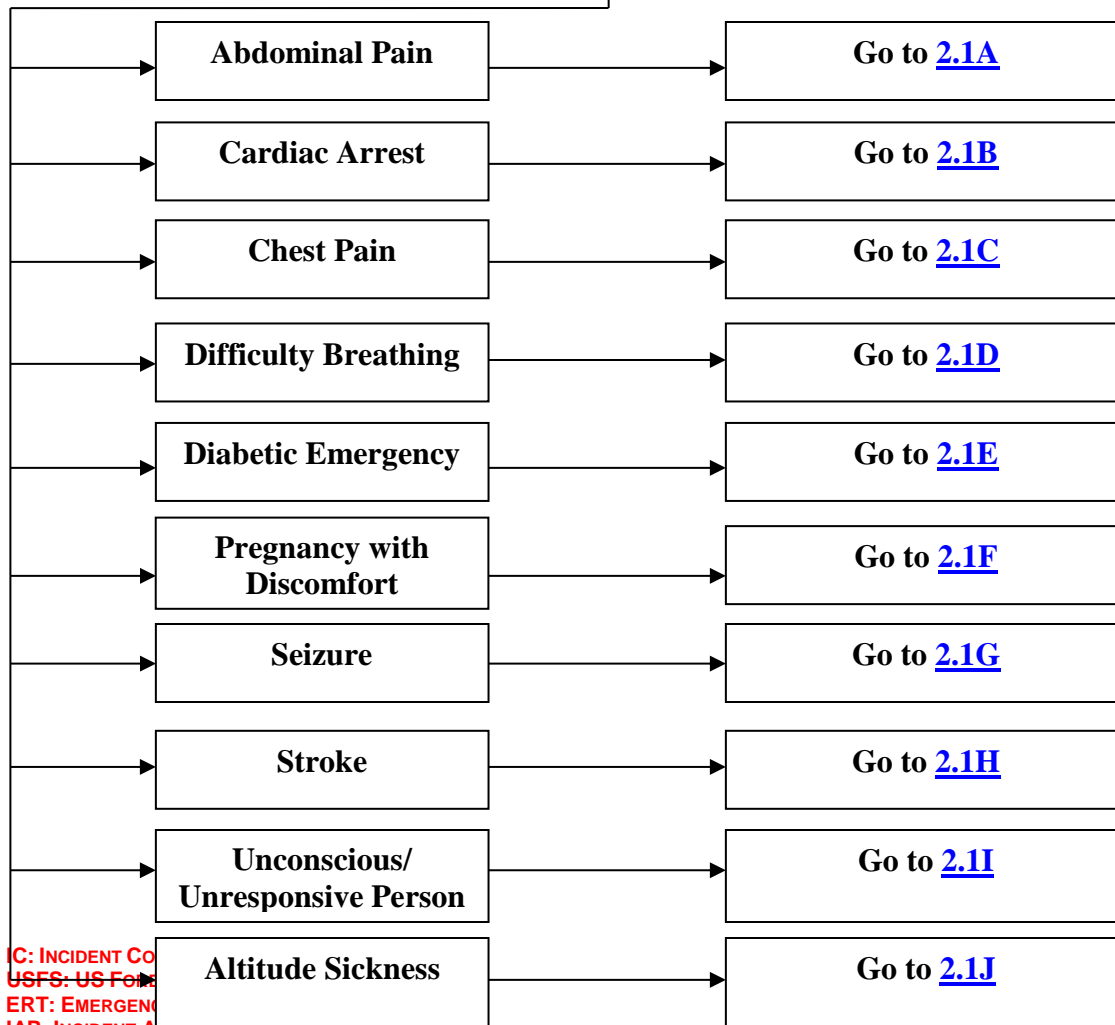

2.1A ABDOMINAL PAIN

USE THIS FOR:

Any person that is complaining of abdominal pain

DO NOT USE THIS FOR:

1. A pregnant patient – GO TO [2.1F](#)
2. Patients that have associated trauma – GO TO [2.2](#)

ASSESS PATIENT (See [2.0](#) for Normal Ranges)

1. Obtain pulse
2. Obtain blood pressure (B/P)

Pulse and B/P within normal range

Determine if patient is responsive

PATIENT IS RESPONSIVE

1. Place patient in position of comfort
2. Have emesis/sick bag available if patient vomits

GO TO [2.6](#)

FOLLOW NON-IMMEDIATE TREATMENT & TRANSPORT PROCEDURES

PATIENT IS UNRESPONSIVE

1. Place patient in recovery position (lying on left side)

Pulse and B/P not within normal range

1. If B/P is low or heart rate elevated, place patient with legs elevated
2. If B/P elevated, place patient in position of comfort
3. Have emesis/sick bag available if patient vomits

GO TO [2.6](#)

FOLLOW IMMEDIATE TREATMENT & TRANSPORT PROCEDURES

2.1B CARDIAC ARREST

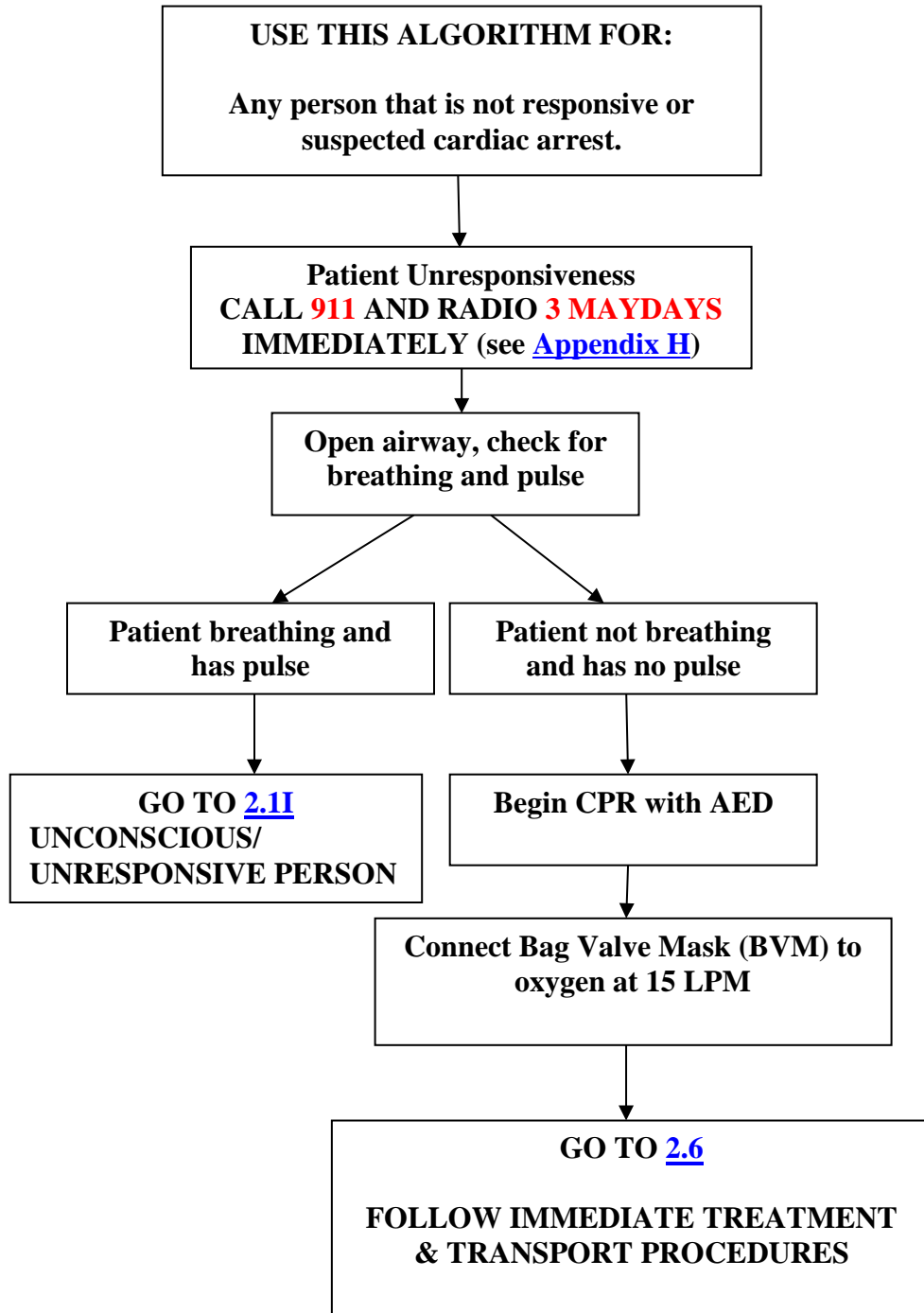

2.1C CHEST PAIN

USE THIS ALGORITHM FOR:

1. Dull, aching, or substernal chest pain or pressure
2. Chest pain with radiating pain to arm, neck, or jaw

DO NOT USE THIS ALGORITHM FOR:

Patients that have associated Trauma – GO TO ALGORITHM [2.2](#)

Place patient on oxygen

ASSESS PATIENT (See [2.0](#) for Normal Ranges)

1. Obtain Pulse
2. Obtain Blood Pressure (B/P)
3. Determine if patient has a history of chest pain

Patient has a history of chest pain
OR
The ERT believes that pain is cardiac in nature

Patient does not have a history of chest pain
OR
The ERT is not sure the pain is cardiac in nature

If the patient is prescribed Nitroglycerine:

1. Assist patient in locating their Nitroglycerine
2. If systolic B/P above 90, allow them to take Nitro every 5 min up to 3 times, less if pain is gone
3. DO NOT allow patient to take more than 3 Nitro.
4. Have patient stop taking Nitro if B/P drops below 90 systolic. If B/P below 90 systolic, place patient with legs elevated

1. Place Patient in Position of Comfort
2. Have Emesis Bag available if patient vomits

GO TO [2.6](#)

FOLLOW IMMEDIATE
TREATMENT & TRANSPORT
PROCEDURES

ERT Members trained in first aid can:

Can give Aspirin if it is available and patient DOES NOT have an allergy to aspirin and patient does not have any recent history of bleeding including ulcers and hemorrhoids

1. Suggested dose of aspirin is 1 adult 325 mg tablet or 4 low-dose (81 mg each) “baby” aspirin.

2.1D DIFFICULTY BREATHING

USE THIS FOR:

All patients complaining of difficulty breathing, shortness of breath, rapid breathing, or respiratory distress

DO NOT USE THIS ALGORITHM FOR:

1. Patients that have associated Trauma – GO TO [2.2](#)
2. Patients that have associated Chest Pain – GO TO [2.1C](#)
3. Patients that are not breathing – GO TO [2.1B](#)

Provide oxygen for patient. Assist only with permission.

ASSESS PATIENT (See [2.0](#) for Normal Ranges)

1. Obtain Pulse
2. Obtain Blood Pressure (B/P)
3. Determine if patient has a history Asthma, Congestive Heart FAILURE (CHF), or Allergic Reactions

ASTHMA

CHF

NO HISTORY

ALLERGIC REACTION

Patient has a prescribed inhaler
ERT members trained in First Aid can assist patient with administration of their prescribed inhaler

Patient has a prescribed EPI Auto-injector
ERT members trained in First Aid can administer an EPI auto-injector if patient is prescribed one

1. Place Patient in Position of Comfort
2. Have Emesis Bag available if patient vomits

GO TO [2.6](#)

FOLLOW IMMEDIATE TREATMENT & TRANSPORT PROCEDURES

2.1E DIABETIC EMERGENCY

USE THIS FOR:

1. Dizziness
2. Confusion
3. Altered behavior / altered level of consciousness
4. Fainting / Syncope

ASSESS PATIENT (See [2.0](#) for Normal Ranges)

1. Obtain Pulse
2. Obtain Blood Pressure (B/P)
3. Obtain blood sugar
4. Determine if patient has a history diabetes

Blood Sugar less than 70

Blood Sugar 70 or over

Determine if patient is able to follow simple commands and is able to swallow

Are there other injuries and/or medical complaints?

NO

YES

NO

YES

ERT Members trained in first aid can:
Administer Glucose Tablets or Glucose Gel
If these are not available the ERT can give:

1. Mentos
2. Skittles
3. Orange juice
4. Whole milk

Place patient in recovery position (lying on side)

Return to [2.0](#)

Does Patient Improve and is blood sugar over 70 after administration of glucose?

GO TO [2.6](#)
FOLLOW NON-IMMEDIATE TREATMENT & TRANSPORT PROCEDURES

NO

YES

GO TO [2.6](#)
FOLLOW IMMEDIATE TREATMENT & TRANSPORT PROCEDURES

This is a serious life threatening emergency – immediate EMS trained personnel and transportation needed

Place patient in recovery position (lying on side)

IC- INCIDENT COMMANDER

2.1F PREGNANCY WITH DISCOMFORT

USE THIS FOR:

1. Pregnant patient with discomfort
2. Signs of labor (contractions, water broke)
3. Pregnant patient with vaginal bleeding

DO NOT USE THIS ALGORITHM FOR:

1. Abdominal pain without signs of labor – GO TO [2.1A](#)
2. Trauma induced vaginal bleeding without signs of labor – GO TO [2.2](#)

NOTIFY EMS AND HAVE HIGHER LEVEL OF CARE
RESPOND IMMEDIATELY (see [Appendix H](#))

ASSESS PATIENT (See [2.0](#) for Normal Ranges)

1. Obtain pulse
2. Obtain blood pressure (B/P)
3. Obtain glucose reading

Vaginal Bleeding

YES

NO

Blood Pressure Under
90 Systolic or Heart
Rate 110 or more?

YES

NO

Is Delivery Eminent?

NO

YES

Place patient
on left side
with head
elevated

Prepare for
Emergency
Delivery

GO TO [2.6](#)

FOLLOW IMMEDIATE
TREATMENT & TRANSPORT
PROCEDURES

Place patient in Shock
position

20 weeks or more – Place
on left side

20 weeks or less – lying on
back with legs elevated

EAM
ICES

2.1G SEIZURE

USE THIS FOR:

Any patient having a seizure

If patient is in active seizure:

1. Prevent them from injury by moving objects away from them
2. DO NOT place anything in the patient's mouth
3. DO NOT restrain them
4. Determine if patient has a history diabetes

Patient seizure stops

It's normal for patient to be confused for a few minutes after seizure

Patient seizure does not stop or patient has multiple seizures with very little time between

ASSESS PATIENT (See [2.0](#) for Normal Ranges)

1. Obtain Pulse
2. Obtain Blood Pressure (B/P)
3. Obtain blood sugar

GO TO [2.6](#)
FOLLOW IMMEDIATE
TREATMENT & TRANSPORT
PROCEDURES

Place patient on
Oxygen

If Blood Sugar is less
than 70

GO TO [2.1E](#)

GO TO [2.6](#)

FOLLOW NON-IMMEDIATE
TREATMENT & TRANSPORT
PROCEDURES

2.1H STROKE

USE THIS FOR:

Patient over 18 with new:

1. Facial droop
2. Unequal grips / arm drift
3. Slurred speech
4. Change in mental status not related to drugs, alcohol, trauma, seizure or diabetes
5. Sudden loss of vision – complete or a portion
6. Ataxia – sudden changes in coordination or inability to make smooth intentional movement in a patient with a normal mental status

DO NOT USE THIS FOR:

1. Respiratory distress – GO TO [2.1D](#)
2. Trauma – GO TO [2.2](#)
3. Unconscious unresponsive – GO TO [2.1I](#)
4. Seizure – GO TO [2.1G](#)
5. Drug or alcohol intoxication

ASSESS PATIENT (See [2.0](#) for Normal Ranges)

1. Obtain Pulse
2. Obtain Blood Pressure (B/P)
3. Obtain Blood Sugar
4. Evaluate for STROKE using Cincinnati Prehospital Stroke Scale

CINCINNATI PREHOSPITAL STROKE SCALE

If any one of the three tests shows abnormal findings, the patient may be having a stroke.

1. Facial Droop
2. Arm Drift
3. Slurred Speech

LOW BLOOD SUGAR <70

GO TO [2.1E](#)

STROKE SCALE

Make note of onset of symptoms and positive or negative exam findings

GO TO [2.6](#)
FOLLOW IMMEDIATE
TREATMENT & TRANSPORT
PROCEDURES

2.1I UNCONSCIOUS / UNRESPONSIVE

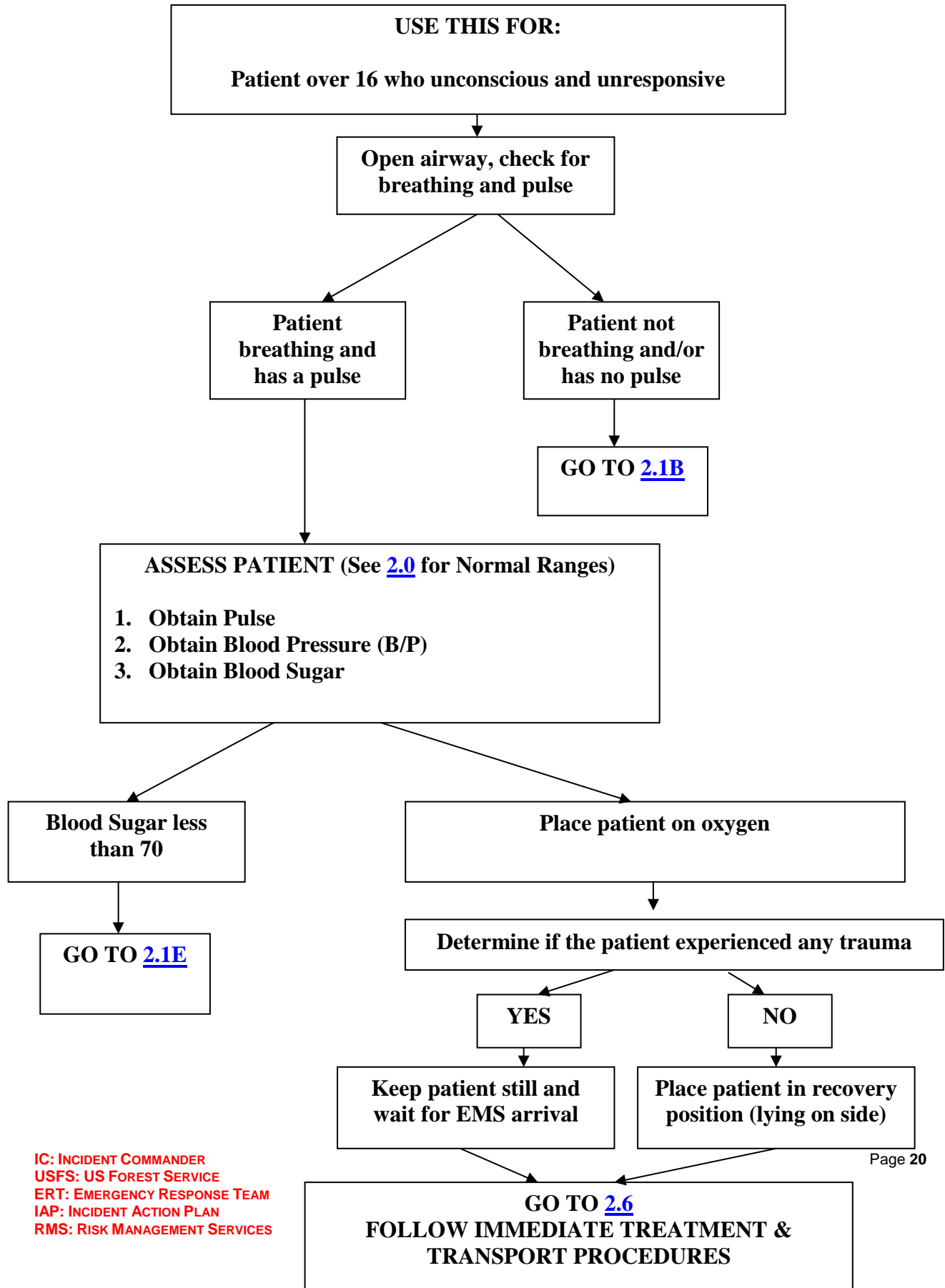

2.1J ALTITUDE SICKNESS, DIZZINESS, HEADACHE

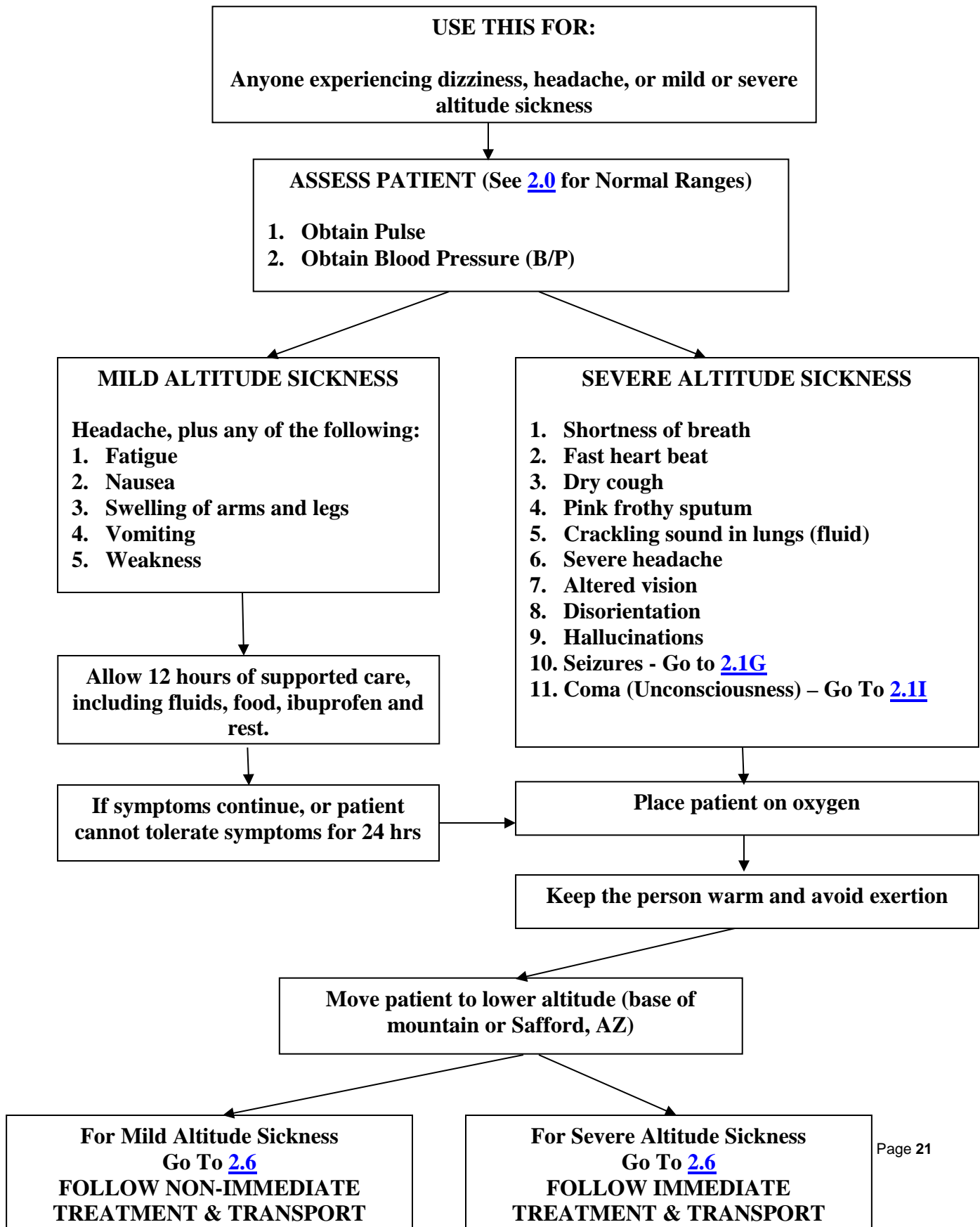

2.2 TRAUMA INJURY

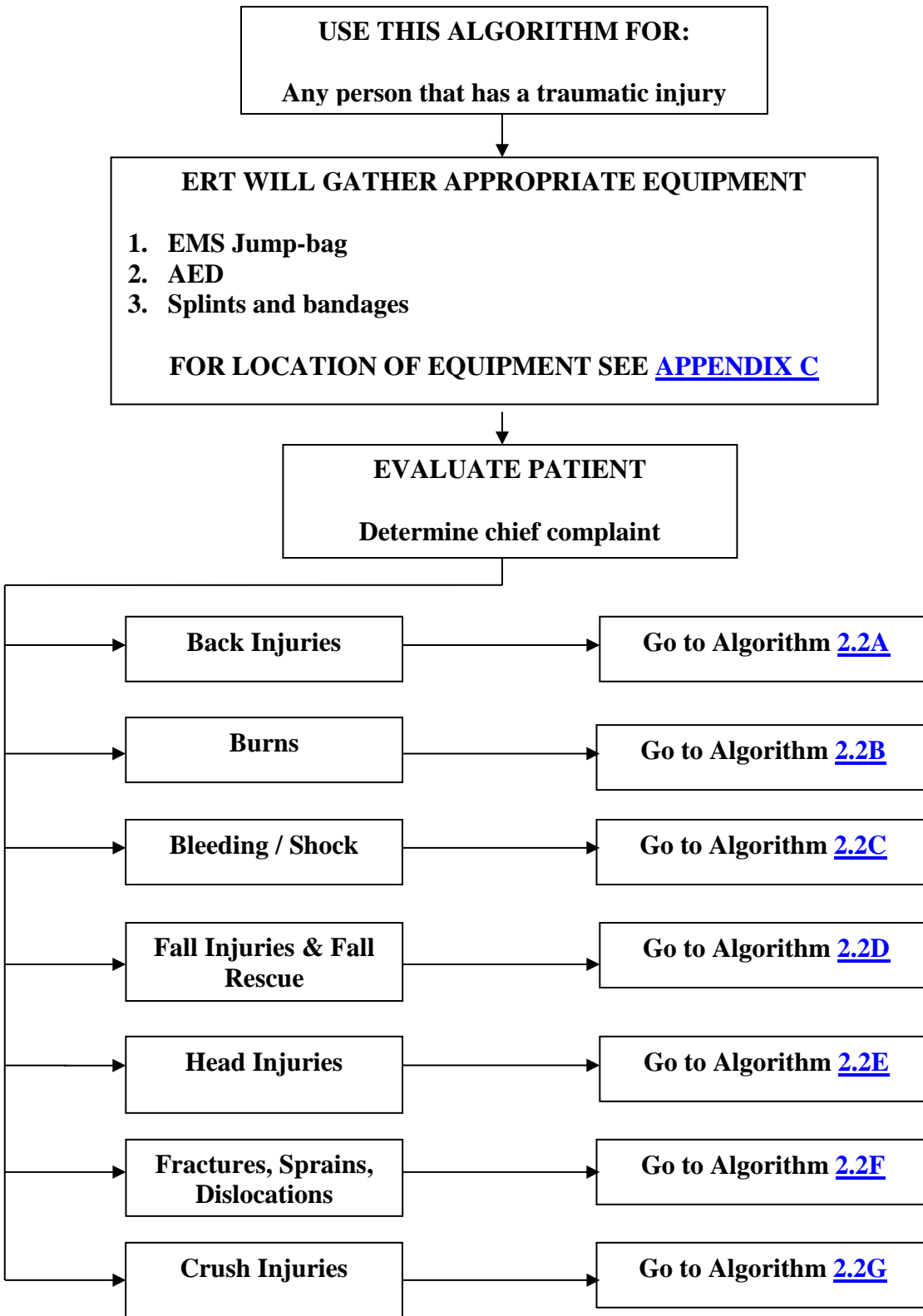

2.2A BACK INJURY

GUIDELINES

1. The terms *spinal immobilization* and *spinal motion restriction* have been used synonymously in the past. Because true spinal immobilization is not possible, the term *spinal motion restriction* is now being used to describe the practice of attempting to maintain the spine in anatomical alignment and minimize gross movement, with or without the use of specific adjuncts such as collars.
2. While complete SMR may be indicated for individuals who have blunt mechanism of injury and who meet high-risk criteria as recommended in the 2010 Guidelines,⁸ the proper technique for SMR requires extensive training and practice to be performed properly and is thus not considered a skill for first aid providers.

USE THIS FOR:

1. Any patient that is responsive and complaining of a back injury/pain without any other trauma.
2. Any violent impact to the head, neck, torso, or pelvis.
3. Any incidents producing sudden acceleration, deceleration, or lateral bending forces to the neck or torso

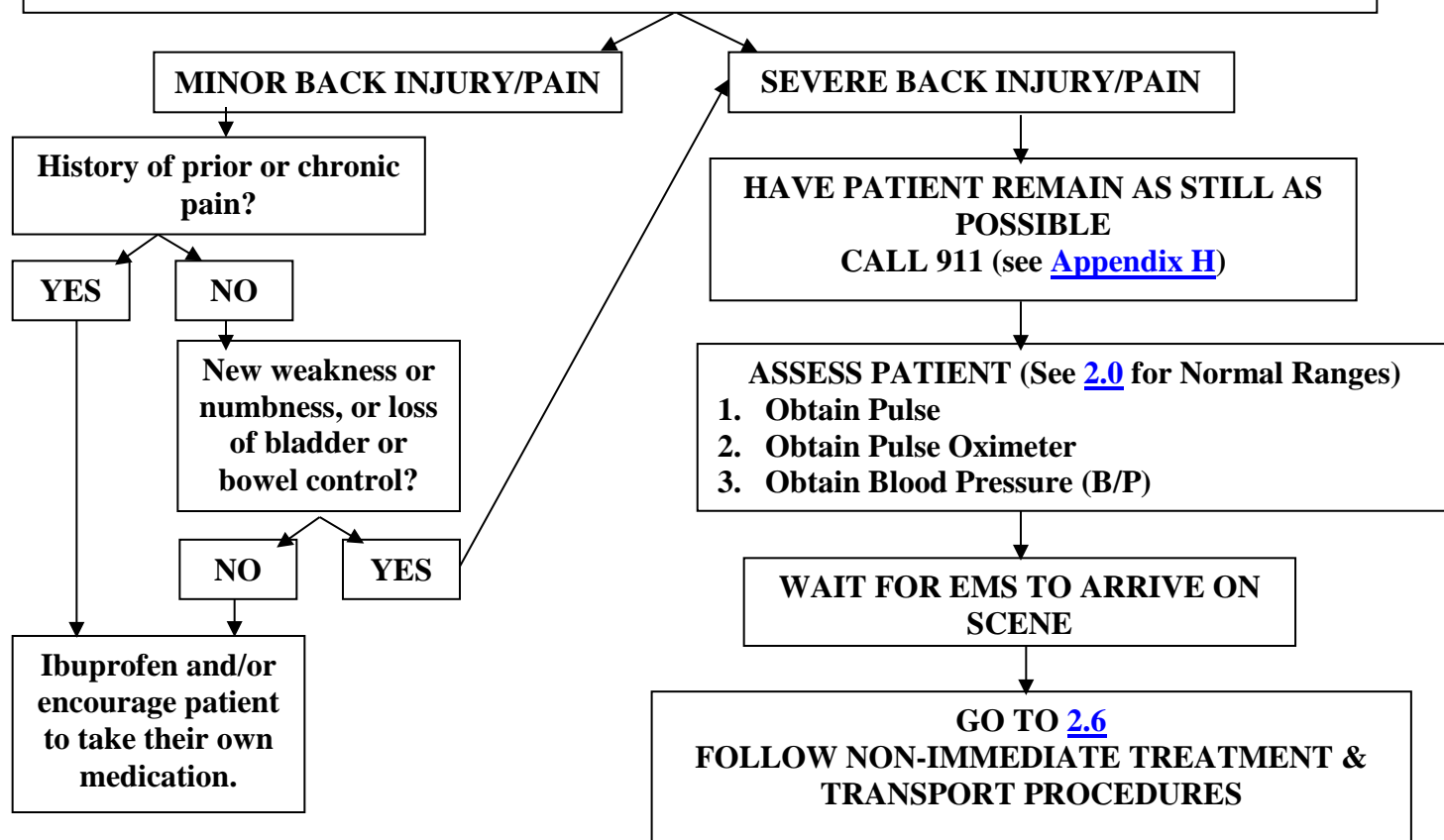

2.2B BURNS

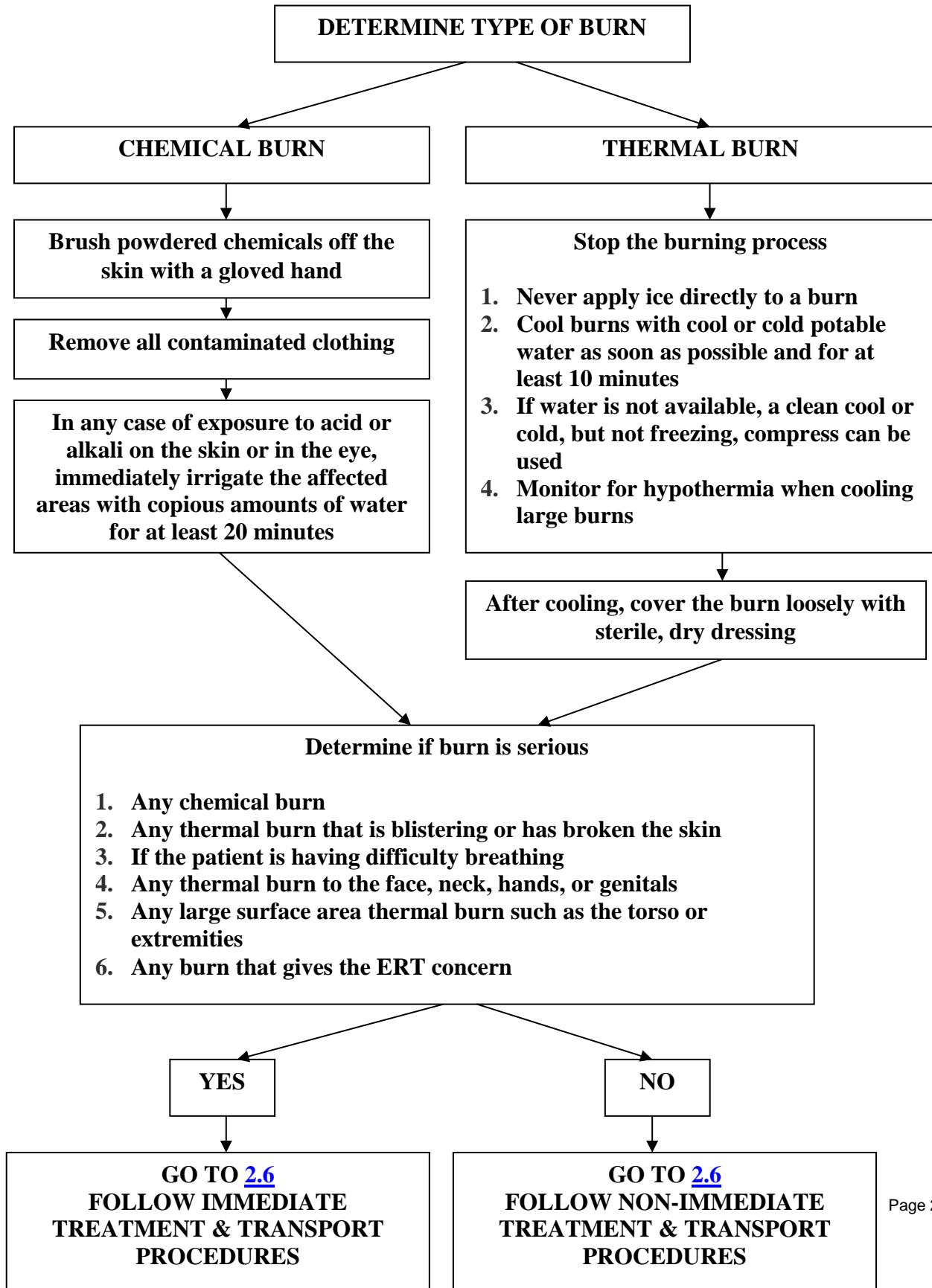

2.2C BLEEDING / SHOCK

USE THIS FOR:

Any patient that has a cut that is bleeding

Attempt to control bleeding with direct pressure with or without gauze and continue to hold direct pressure.

BLEEDING CONTROLLED

BLEEDING NOT CONTROLLED

ASSESS PATIENT

EXTREME / SEVERE BLEEDING

EXTREME / SEVERE BLEEDING

If B/P is normal or elevated, place patient in position of comfort

If B/P is low or heart rate elevated, place patient with legs elevated

In a place where a tourniquet cannot be applied: trunk, Abdomen, Groin, Head

Arm or leg

Attempt to control bleeding with application hemostatic dressings

Attempt to control bleeding with application of a tourniquet. Note time of application of tourniquet and communicate this to EMS providers

ASSESS PATIENT
(See [2.0](#) for Normal Ranges)

If B/P is low or heart rate elevated, place patient with legs elevated

If B/P is normal or elevated, place patient in position of comfort

GO TO [2.6](#)
FOLLOW NON-IMMEDIATE
TREATMENT & TRANSPORT
PROCEDURES

GO TO [2.6](#)
FOLLOW IMMEDIATE
TREATMENT & TRANSPORT
PROCEDURES

2.2D FALL INJURIES & FALL RESCUE

GUIDELINES

1. ERT Members should not try to rescue or move a patient that has experienced a significant fall that has caused head, back, or neck injuries unless absolutely necessary to keep the patient from further injury or harm.
2. Make sure the area is safe and free from electrical energy and any mechanical movement from machinery.
3. **For Patient Suspended in Fall Protection Gear, see [M004s00012](#) LBTO Fall Rescue Program for Instructions on how to rescue someone suspended in fall protection gear.**

HAVE PATIENT REMAIN AS STILL AS POSSIBLE

ASSESS PATIENT (See [2.0](#) for Normal Ranges)

1. Obtain Pulse
2. Obtain Pulse Oximeter
3. Obtain Blood Pressure (B/P)

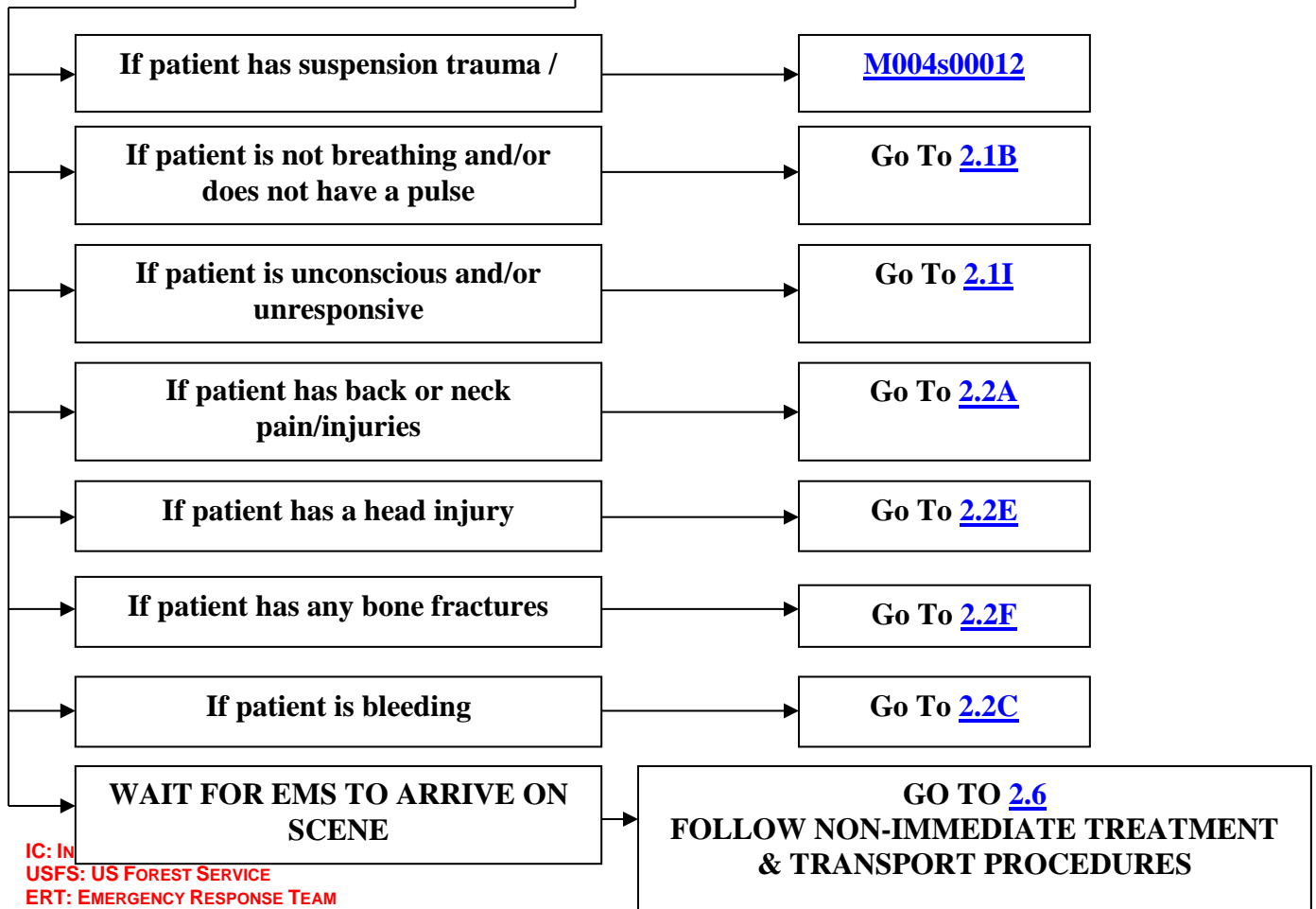

IC: IN
USFS: US FOREST SERVICE
ERT: EMERGENCY RESPONSE TEAM
IAP: INCIDENT ACTION PLAN
RMS: RISK MANAGEMENT SERVICES

LBT-Specific Reference Documents:

- Fall Rescue Program ([M004s00012](#))

2.2E HEAD INJURIES

GUIDELINES

1. Signs and symptoms of a concussion are complex but include:
 - a. Feeling stunned or dazed
 - b. Headache
 - c. Nausea
 - d. Dizziness
 - e. Unsteadiness (difficulty in balance)
 - f. Visual disturbances
 - g. Confusion
 - h. Loss of memory
2. Change may be subtle yet progressive. If there is any chance of a head injury, then the patient should be evaluated by EMS providers.

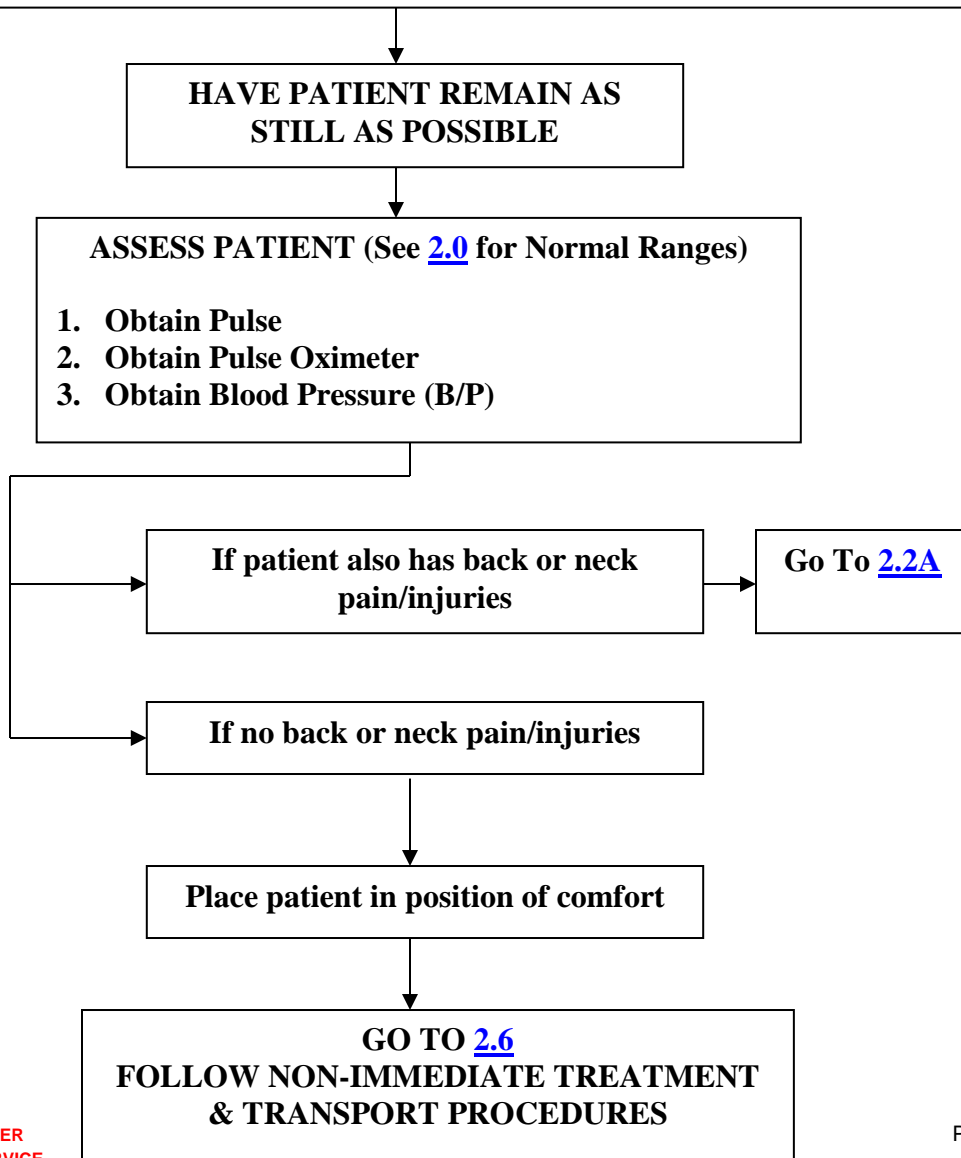

2.2F FRACTURES, SPRAINS, DISLOCATIONS

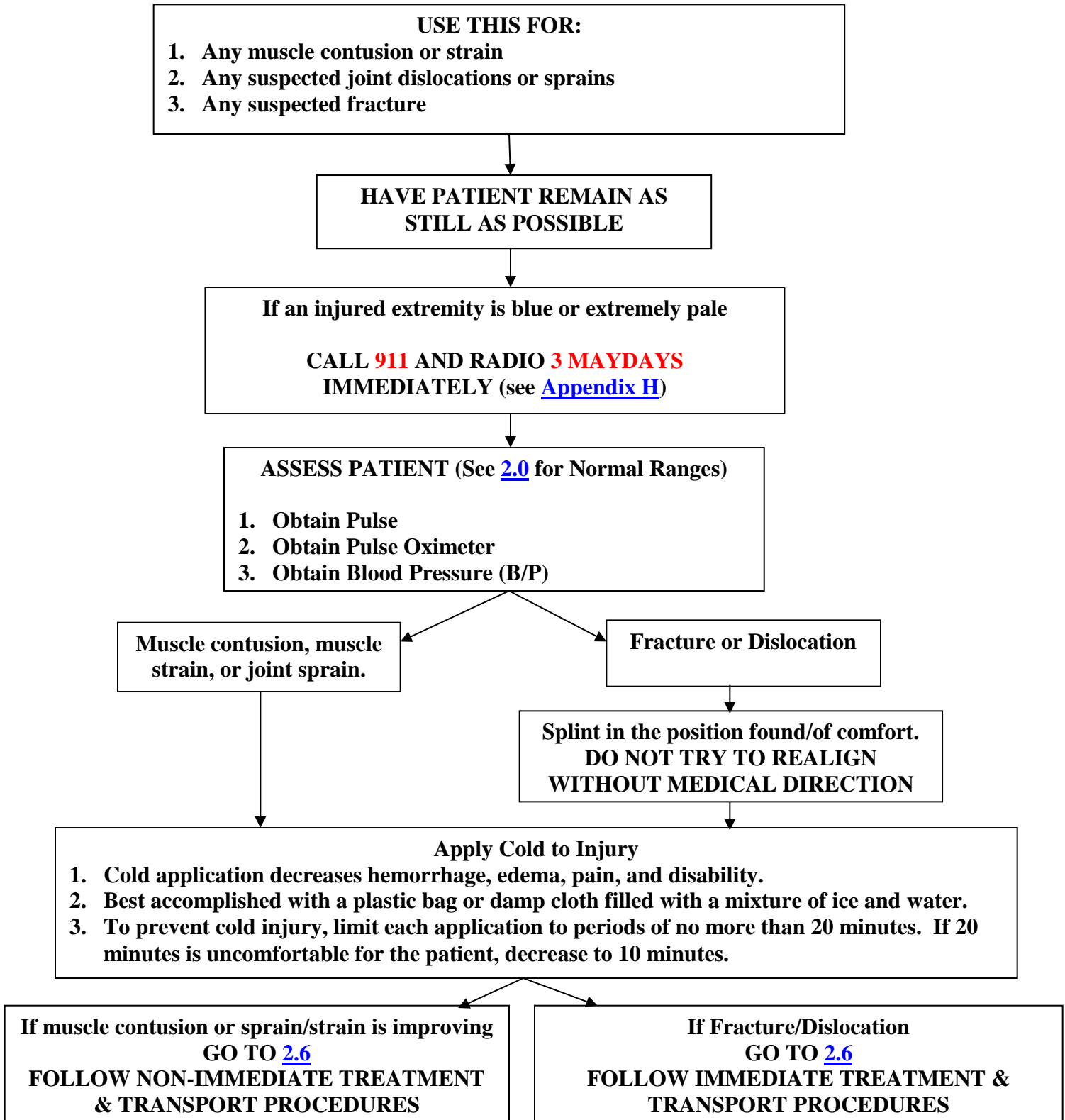

2.2G CRUSH INJURIES

GUIDELINES

1. A crush injury occurs when force or pressure is put on a body part. This most often occurs when part of the body is squeezed between 2 heavy objects.
2. ERT Members should not try to move a patient that has experienced a significant crushing injury.
3. Make sure the area is safe and free from electrical energy and any mechanical movement from machinery.
4. Symptoms can include:
 - a. Bleeding
 - b. Bruising
 - c. Compartment Syndrome (Increased pressure in an arm or leg that causes serious muscle, nerve, blood vessel, and tissue damage)
 - d. Fractures
 - e. Lacerations

CALL 911 AND RADIO 3 MAYDAYS IMMEDIATELY (see [Appendix H](#))

If possible do not move the patient but wait for EMS to arrive on scene

HAVE PATIENT REMAIN AS STILL AS POSSIBLE

ASSESS PATIENT (See [2.0](#) for Normal Ranges)

1. Obtain Pulse
2. Obtain Pulse Oximeter
3. Obtain Blood Pressure (B/P)

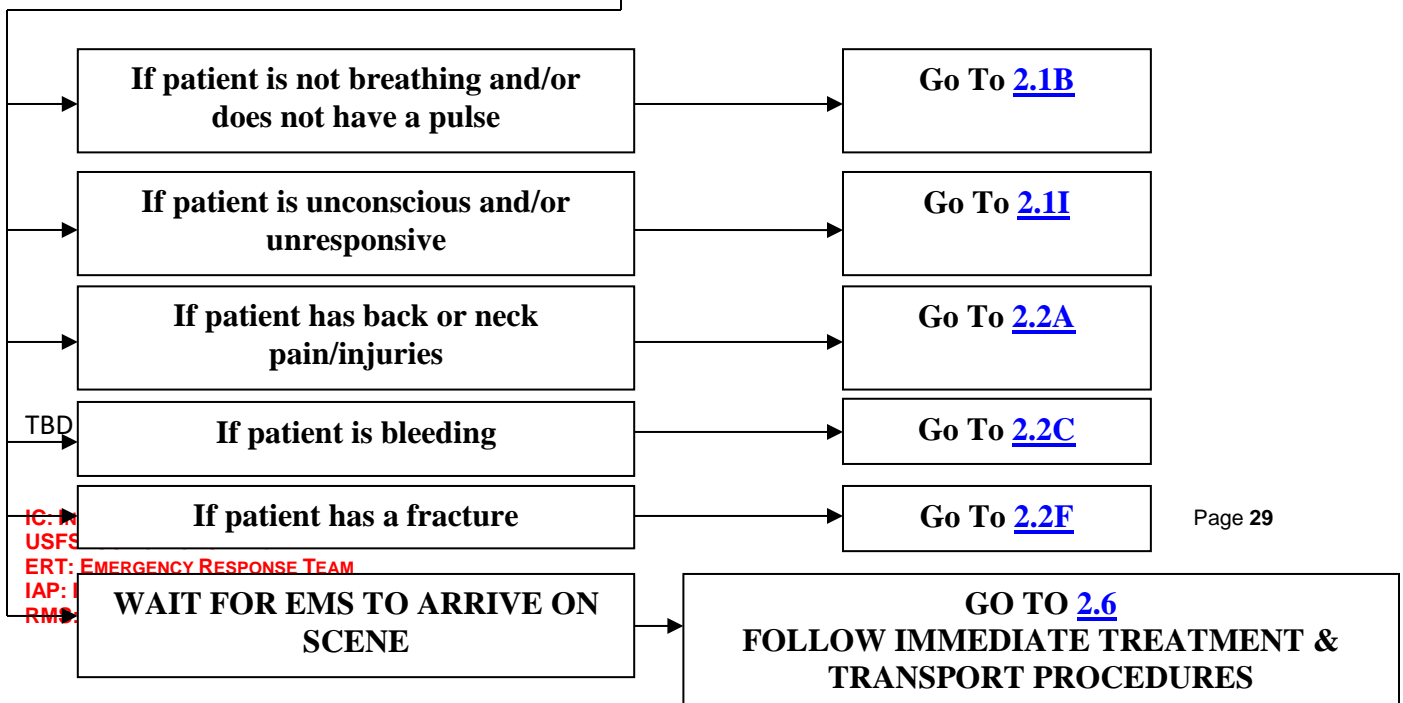

2.3 ELECTRICAL INJURY OR ELECTROCUTION

GUIDELINES

1. The severity of electrical injuries can vary widely, from an unpleasant tingling sensation caused by low-intensity current to thermal burns, cardiopulmonary arrest, and death.
2. Thermal burns may result from burning clothing that is in contact with the skin or from electrical current traversing a portion of the body.
3. When current traverses the body, thermal burns may be present at the entry and exit points and along its internal pathway.
4. Cardiopulmonary arrest is the primary cause of immediate death from electrocution.
5. Respiratory arrest may result from electrical injury to the respiratory center in the brain or from muscle contractions/spasms or paralysis of respiratory muscles.

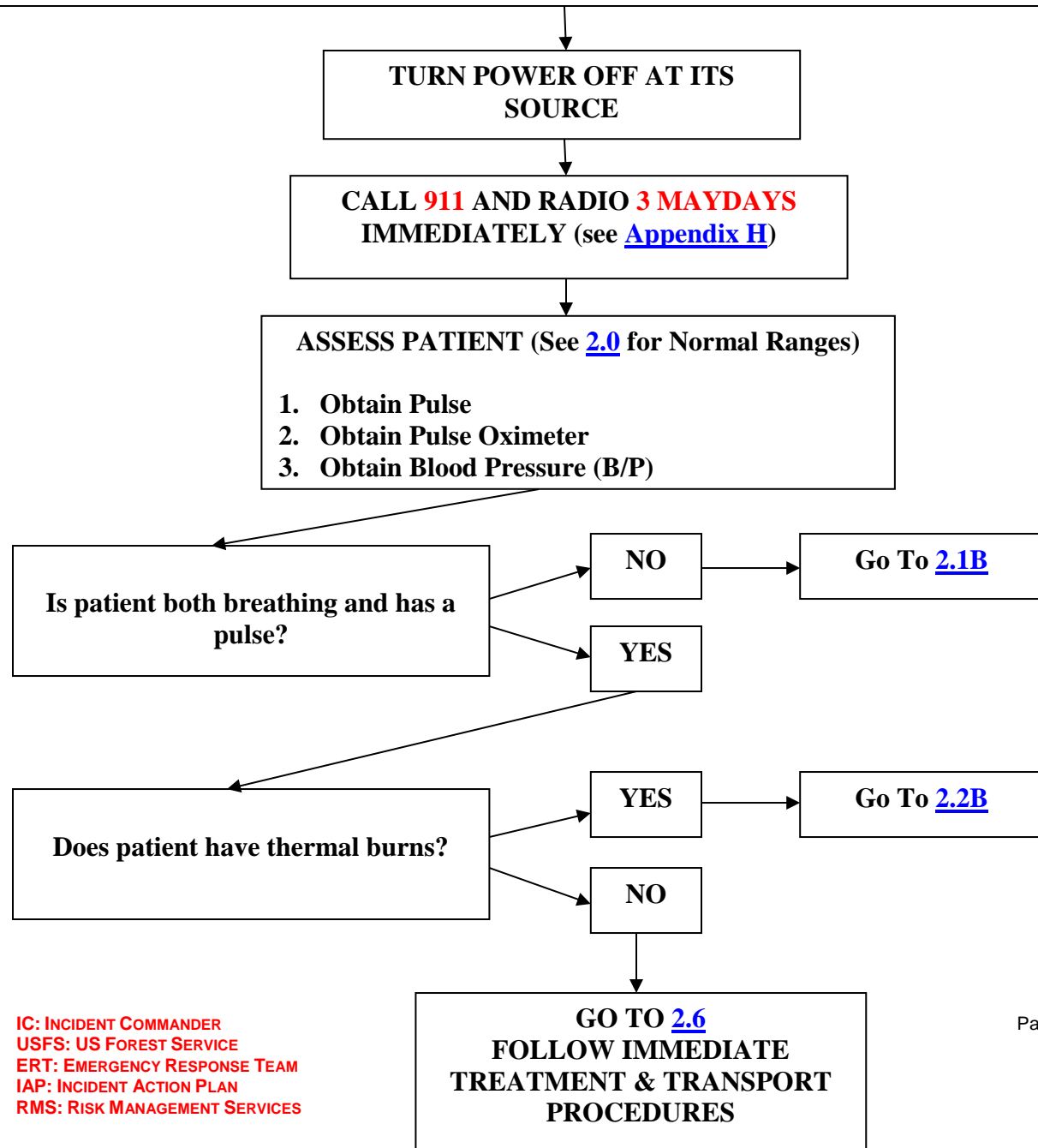

2.4 CHEMICAL EXPOSURE

GUIDELINES

1. For all chemical exposures, only respond if it is safe to do so and you have the proper personal protective equipment.
2. Liquid nitrogen exposures also have the risk of asphyxiation.

FOR LOCATION OF EQUIPMENT SEE [APPENDIX C](#)

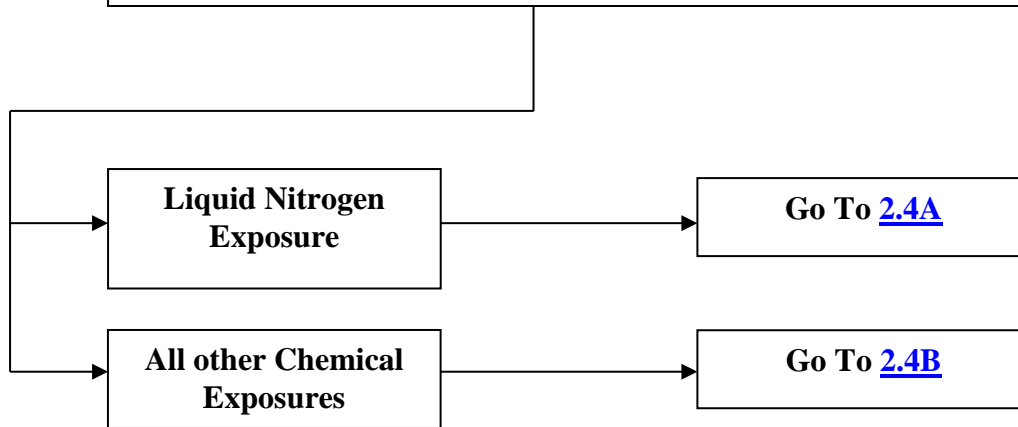

2.4a LIQUID NITROGEN EXPOSURE

USE THIS ALGORITHM FOR:

For any person that may have been exposed to Liquid Nitrogen

1. For a Liquid Nitrogen release, also follow Algorithm [5.1](#).
2. Beware of oxygen deficiency in the vicinity of a major cryogenic accident. Cold gas will displace ambient air including oxygen.
3. If it is safe to do so, remove victims to a known safe zone before administering first aid.
4. Call 911 to start Emergency Medical Services (EMS) response (see [Appendix H](#)) and notify the building manager.
5. Severe cryogenic "burns" are similar to burns from fire. Do not rub skin or thaw frozen flesh with heat, this causes more damage. Slowly thaw skin with warm water 100°F (38°C); do not overheat or burns may occur. Cleanse with mild soap and water, and cover wound with loose gauze to prevent infection.
6. Place person on oxygen if they are experiencing any difficulty breathing or have been exposed to an asphyxiate (Liquid Nitrogen).

GO TO [2.6](#)
FOLLOW IMMEDIATE TREATMENT & TRANSPORT
PROCEDURES

2.4b CHEMICAL EXPOSURE

USE THIS ALGORITHM FOR:

For any person that may have been exposed to a chemical besides liquid nitrogen (for liquid nitrogen exposure, see Algorithm [2.4a](#)).

Notify a trained on-duty ERT Member (see [Appendix A](#))

1. For a chemical spill or release (Not Liquid Nitrogen), also follow Algorithm [5.0](#)
2. For a Liquid Nitrogen release, also follow Algorithm [5.1](#).
3. For Liquid Nitrogen Exposure, follow Algorithm [2.4a](#)

1. Identify the hazmat material spilled and/or released
2. Review the Safety Data Sheets (SDS).

Safely remove person from the product

Decontaminate Personnel

1. Remove affected clothing
2. Wash affected skin for at least 20 minutes
3. If eyes are involved, flush with water for at least 20 minutes

Follow first aid guidelines on the SDS

Place person on oxygen if they are experiencing any difficulty breathing or have been exposed to an asphyxiate (Liquid Nitrogen)

GO TO [2.6](#)
FOLLOW IMMEDIATE TREATMENT & TRANSPORT PROCEDURES

2.5 THERMAL (COLD/HEAT) EXPOSURE

ERT WILL GATHER APPROPRIATE EQUIPMENT

3. EMS Jump-bag
4. AED
5. Splints and bandages

FOR LOCATION OF EQUIPMENT SEE [APPENDIX C](#)

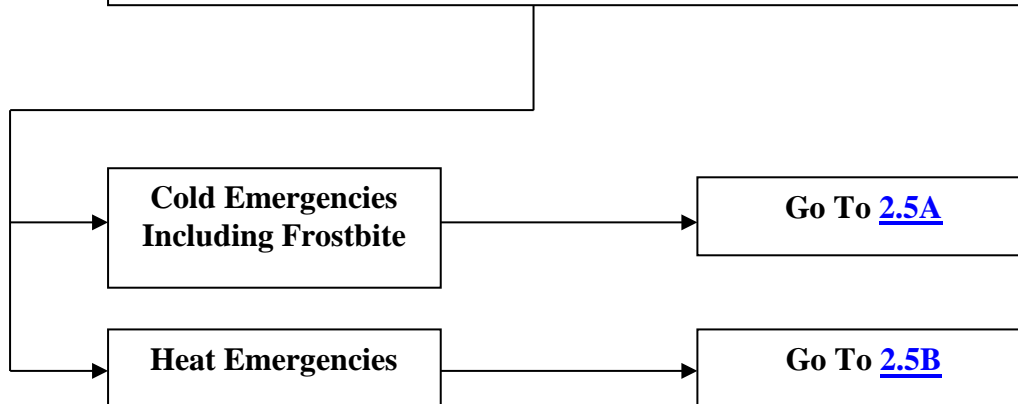

2.5A COLD EMERGENCY

USE THIS FOR

1. Hypothermia; which is caused by exposure to cold
2. Frostbite; which usually affects an exposed part of the body such as the extremities and nose

1. Remove patient from the cold environment and into a warm environment
2. Remove any and all wet clothing and wrap body surfaces with dry blankets or dry clothing

Since the observatory site is in a remote location, begin active re-warming.
 1. Place patient near a heat source.

Assess mental status

Abnormal or
Unconscious/
Unresponsive
GO TO [2.1I](#)

Conscious within normal limits
Evaluate the patient for any signs of frostbite

Frostbite present

No frostbite present

Do not re-warm the frostbite
if is any chance it might
refreeze

While re-warming is being
completed

Major frostbite

Minor frostbite

**GO TO [2.6](#)
FOLLOW IMMEDIATE
TREATMENT & TRANSPORT
PROCEDURES**

Severe or deep frostbite
should be re-warmed
as soon as possible, as
long as you ensure
there's no chance of
refreezing. This is best
accomplished by immersing
the part in water about the
temperature of a
comfortable hot tub. Be
prepared to start warming
replacement water.

Re-warm using skin
to skin contact such as
a warm hand

ER
VICE
PONSE TEAM
LAN
NT SERVICES

2.5B HEAT EMERGENCY

USE THIS FOR

1. Heat cramps, which are painful involuntary muscle spasms that most often affect the calves, arms, abdominal muscles, and back
2. Heat exhaustion, which is a serious condition because it can rapidly advance to heat stroke. Signs and symptoms include: nausea, dizziness, muscle cramps, feeling faint, fatigue, and heavy sweating
3. Heat Stroke; which is a serious condition because patient's body cannot cool itself. Signs and symptom include all the symptoms of heat exhaustion PLUS signs of neurologic impairment such as confusion, ataxia (discoordination of movements) or seizure. The patient may no longer be sweating.

HEAT CRAMPS

1. Remove from hot environment
2. Place in cool environment
3. Have patient rest
4. Have patient drink cool electrolyte-carbohydrate mixture such as juice, milk, or commercial electrolyte-carbohydrate drink
5. Stretching, icing, and massaging painful muscles may help

HEAT EXHAUSTION

1. Remove from hot environment
2. Place in cool environment
3. Have patient lie down
4. Remove as much clothing as possible
5. Cool patient with cool water spray
6. Have patient drink cool electrolyte-carbohydrate mixture such as juice, milk, or commercial electrolyte-

HEAT STROKE

1. Remove from hot environment
2. With assistance of medical direction, immerse patient up to the chin in cold water if feasible. If not available, cool the patient with evaporation using cool spray and a fan. Stop when patient's core is <40C
3. Do not force the patient to drink liquids

GO TO [2.6](#)
FOLLOW NON-IMMEDIATE
TREATMENT & TRANSPORT
PROCEDURES

GO TO [2.6](#)
FOLLOW IMMEDIATE
TREATMENT & TRANSPORT
PROCEDURES

2.6 TRANSPORT DECISION

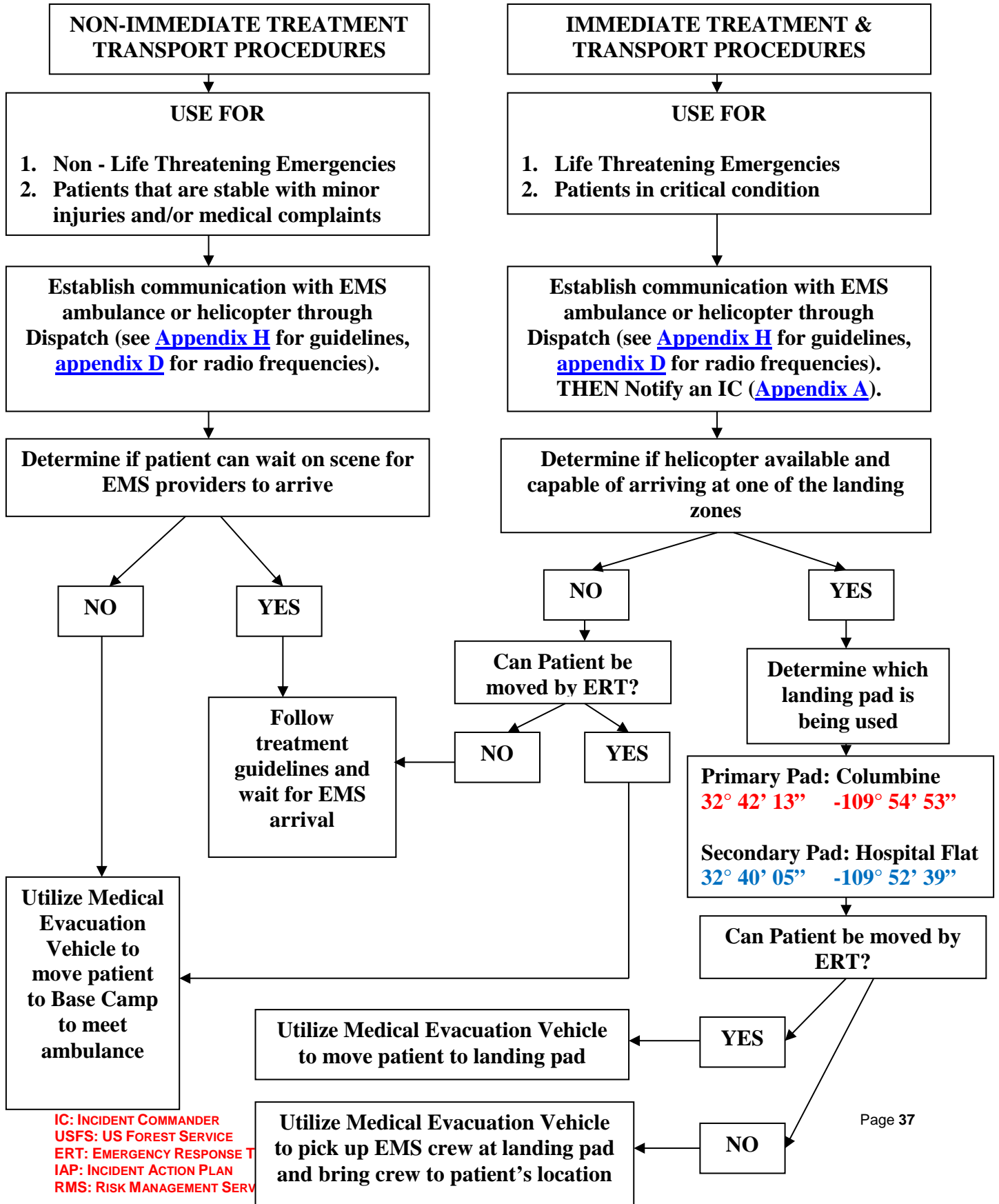

IC: INCIDENT COMMANDER
 USFS: US FOREST SERVICE
 ERT: EMERGENCY RESPONSE TEAM
 IAP: INCIDENT ACTION PLAN
 RMS: RISK MANAGEMENT SERVICE

3.0 COMMUNICATIONS FAILURE

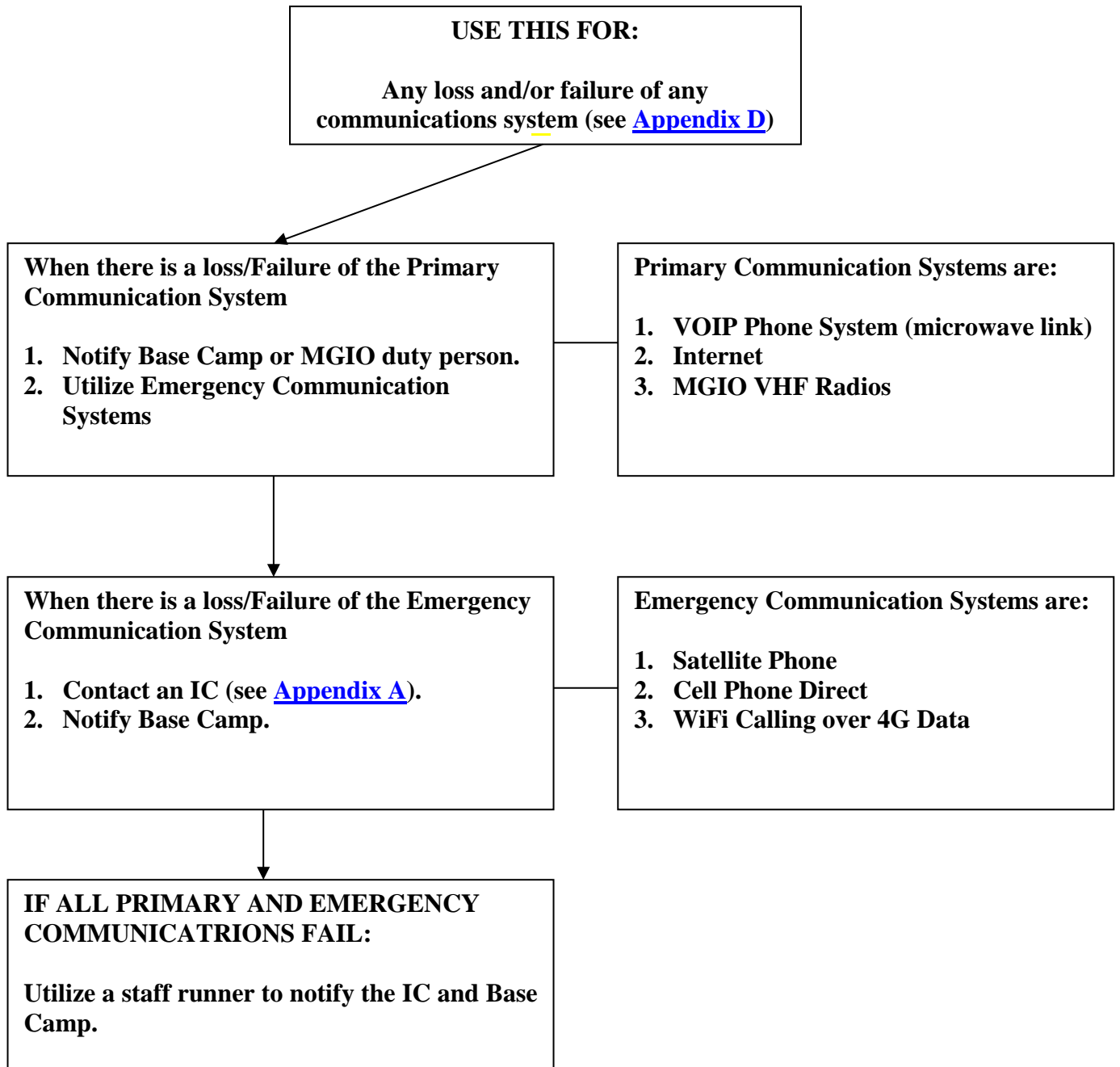

4.0 FIRES

USE THIS FOR:

1. Any structure fire that cannot be immediately extinguished with available extinguisher.
2. An explosion.
3. Any forest fire that threatens the Observatory.

IF FIRE ALARM IS GOING OFF AND NO FIRE IS OBVIOUS, GO TO [4.4](#).

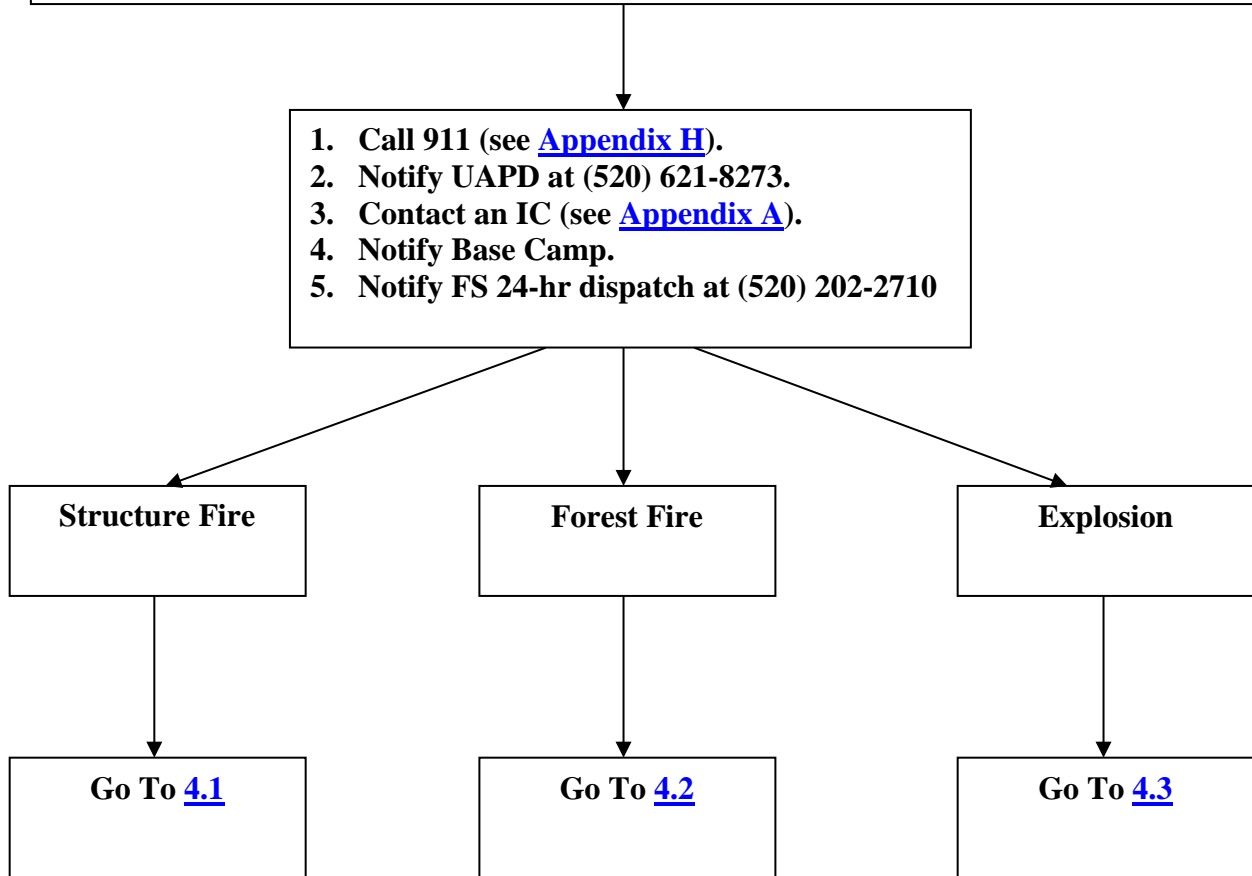

DESCRIPTION OF FLAMMABLE STORAGE ON SITE:

SEE [APPENDIX J](#) HAZARDOUS MATERIALS: CHEMICAL STORAGE

4.1 STRUCTURE FIRE

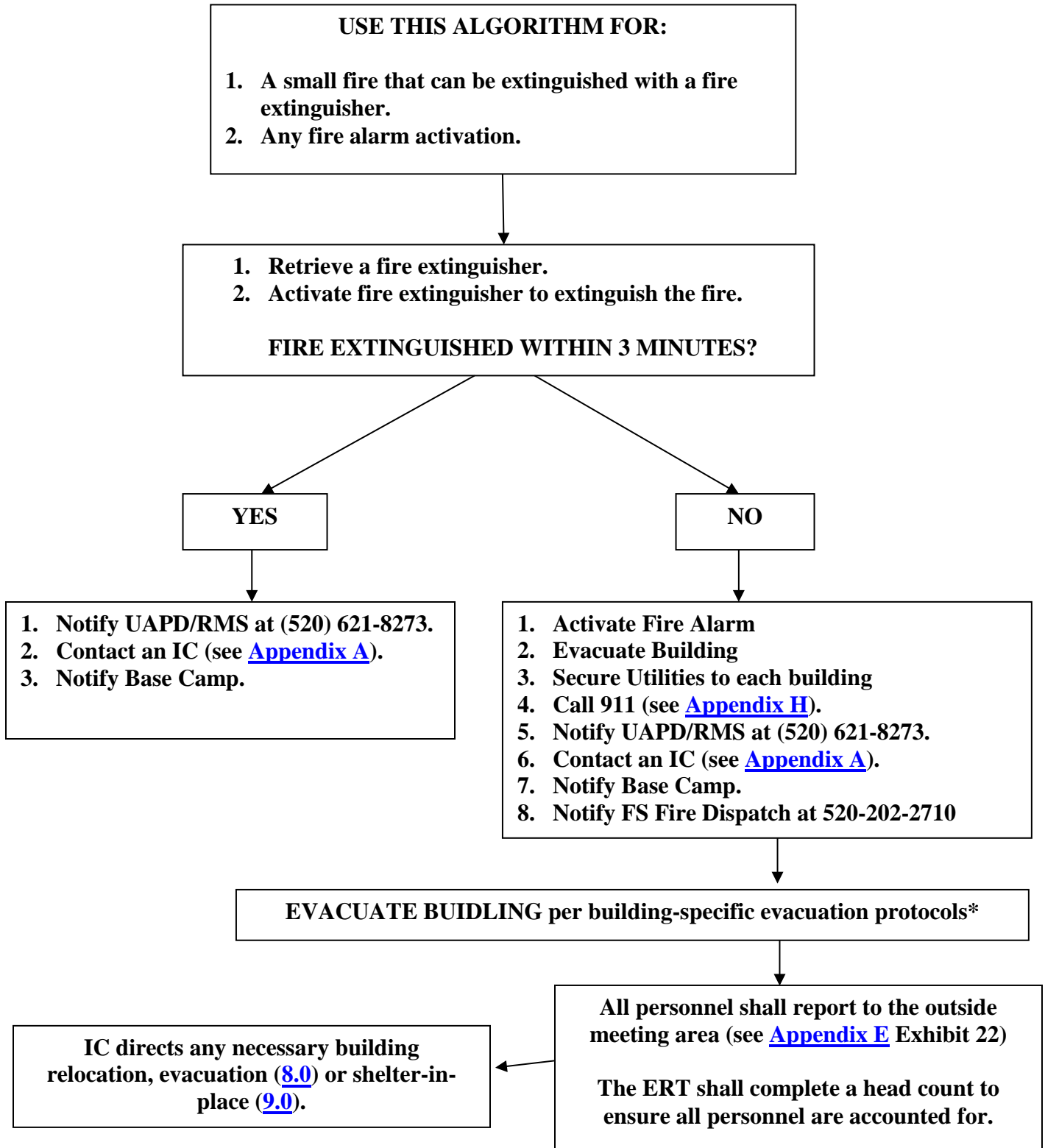

IC: INCIDENT COMMANDER
USFS: US FOREST SERVICE
ERT: EMERGENCY RESPONSE TEAM
IAP: INCIDENT ACTION PLAN
RMS: RISK MANAGEMENT SERVICES

*LBT-Specific Reference Documents:

- LBTO Emergency Action Plan (EAP) M004s00310
- LBTO Structure Fire Contingency Plan ([M004s00005](#))

4.2 FOREST FIRE

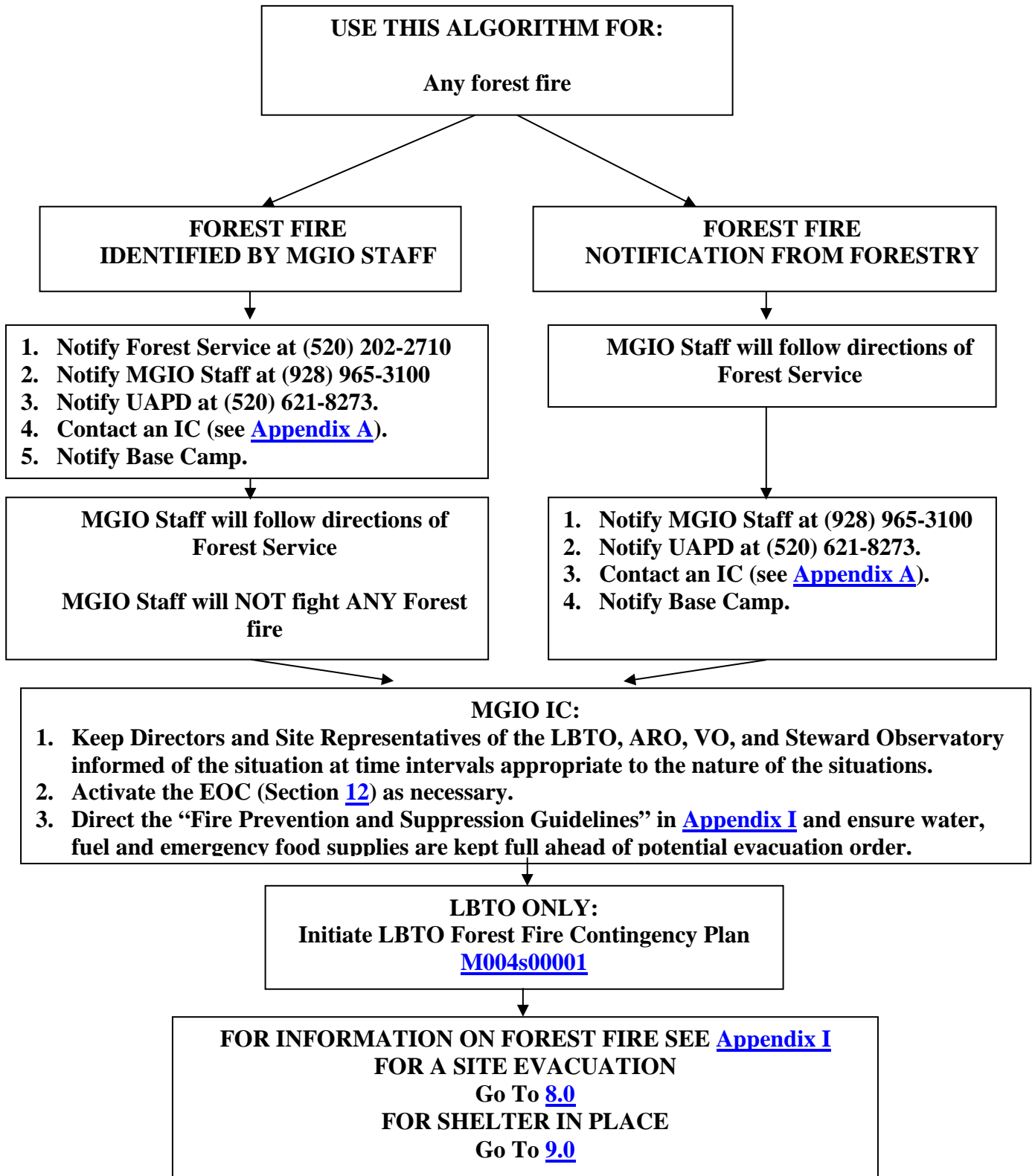

IC: INCIDENT COMMANDER
USFS: US FOREST SERVICE
ERT: EMERGENCY RESPONSE TEAM
IAP: INCIDENT ACTION PLAN
RMS: RISK MANAGEMENT SERVICES

LBT-Specific Reference Documents:

- LBTO Emergency Action Plan (EAP) M004s00310
- LBTO Forest Fire Contingency Plan ([M004s00001](#))

4.3 EXPLOSION

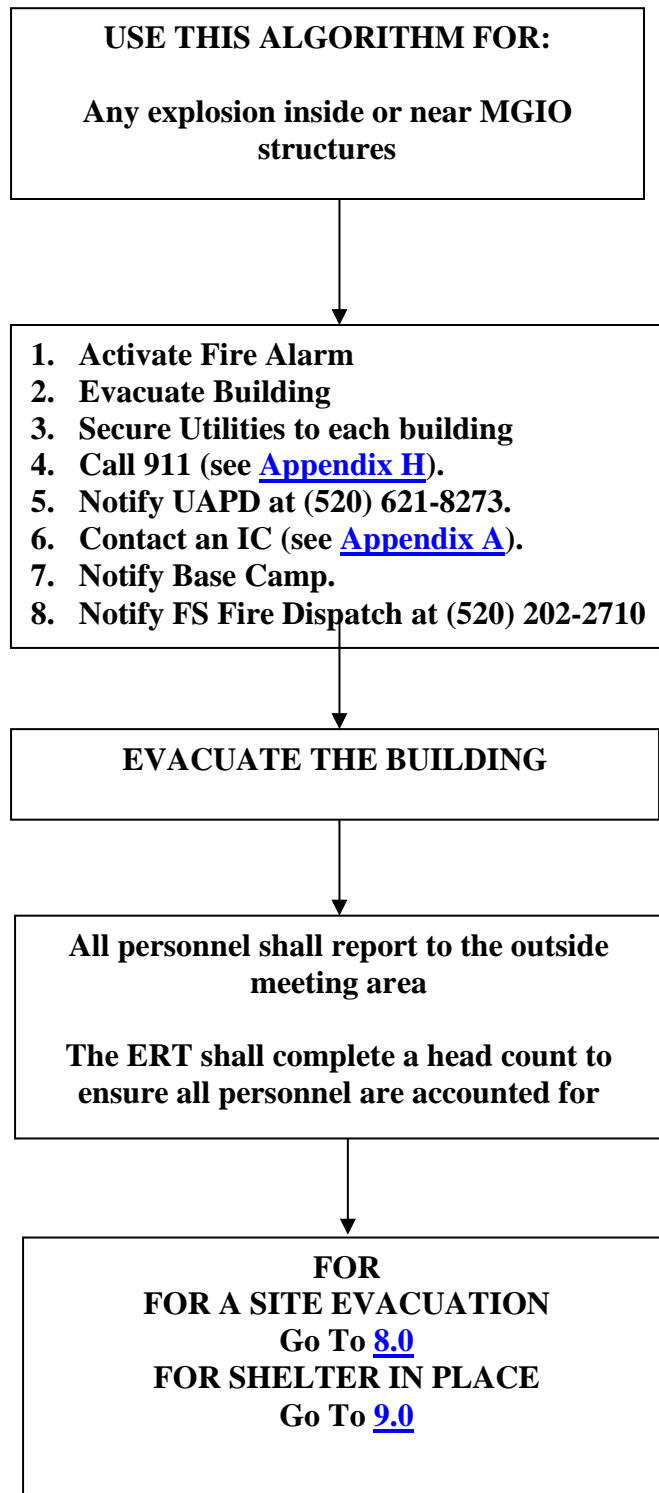

4.4 FIRE ALARM GOING OFF

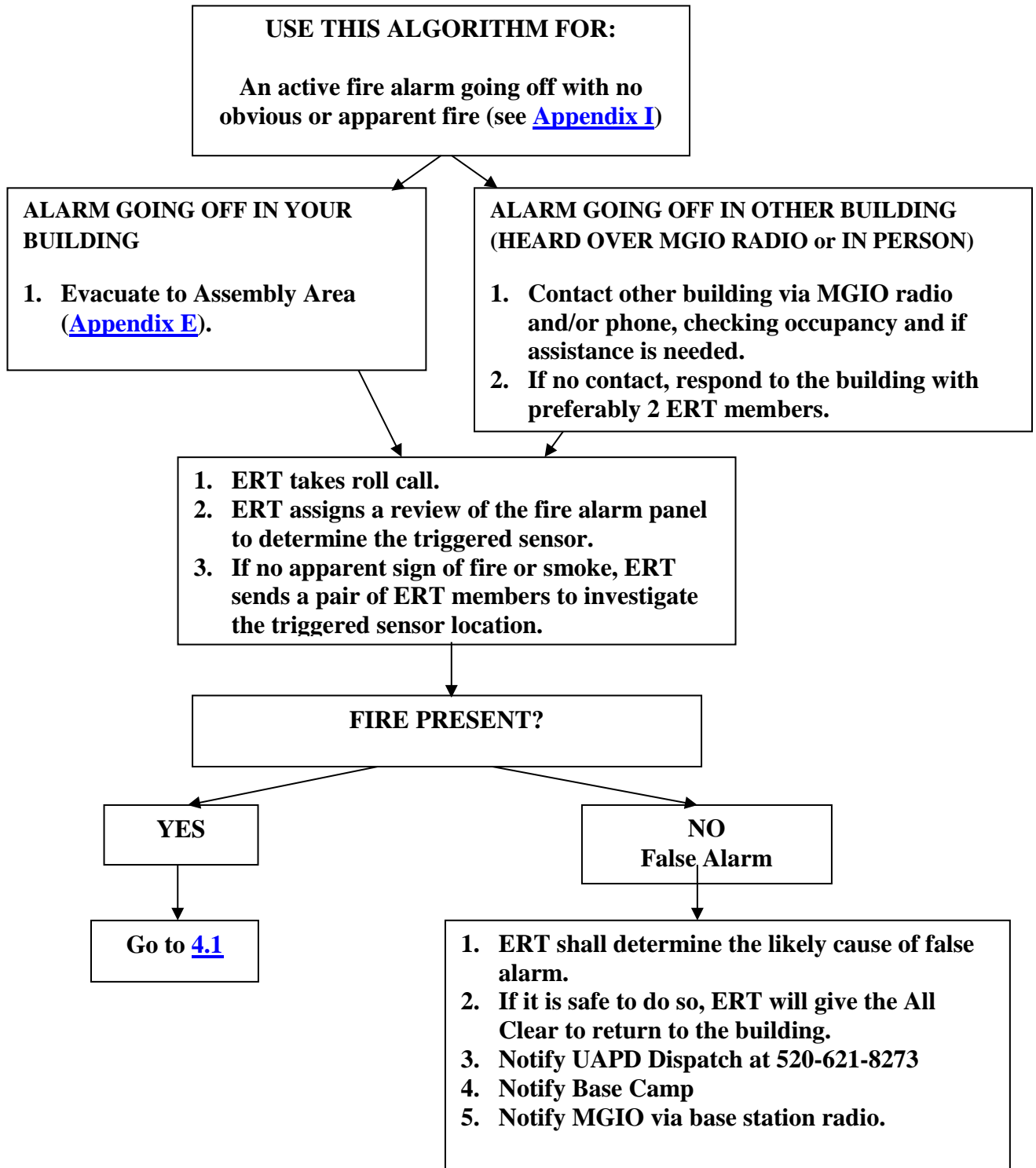

5.0 CHEMICAL SPILL AND/OR RELEASE

USE THIS ALGORITHM FOR:

1. A product that has been spilled has a Threshold Limit Value (TLV) recommended by the American Conference of Government Industrial Hygienists of less than 10 ppm (parts per million).
2. The spilled product is a hazardous material or petroleum product with the potential for ground water or surface water contamination, or the product is capable of being carried off-site via surface run-off.
3. The spilled product cannot be contained on-site, resulting in a potential for off-site soil contamination and/or ground or surface water pollution.
4. Any spill or release that cannot be contained and cleaned up on-site with equipment and procedures that are in place.
5. For a Liquid Nitrogen Release Go To [5.1](#)

LEAVE THE AREA IMMEDIATELY if there is an oxygen deficiency or inhalation risk.
Notify a trained on-duty ERT Member and then an IC (see [Appendix A](#)).

1. Identifying the hazmat material spilled and/or released
2. Reviewing the Safety Data Sheets (SDS).
3. Determining the source of the spill or release.
4. Estimating the quantity of material released and the rate of release
5. Determine the direction the spill and/or release is moving
6. Determining the potential for fire and/or explosion.
7. Estimating the area under influence of the release.
8. SEE [APPENDIX J](#) for Guidance.

DID ANYONE COME IN CONTACT WITH MATERIAL?

YES

NO

Go To [2.4](#)

1. Evacuate Building
2. Secure Utility Services to Buildings
3. All personnel shall report to the outside meeting area
4. The ERT shall complete a head count to ensure all personnel are accounted for.
5. Initiate the Chemical Response in [Appendix J](#).

IC: INCIDENT COMMANDER
USFS: US FOREST SERVICE
ERT: EMERGENCY RESPONSE TEAM
IAP: INCIDENT ACTION PLAN
RMS: RISK MANAGEMENT SERVICES

IC: INCIDENT
USFS: US FOREST SERVICE
ERT: EMERGENCY RESPONSE TEAM

1. Contact an IC (see [Appendix A](#)) and Notify Base Camp.
2. IC to notify UAPD, RMS Emergency Coordinator, and Forest Service ([Appendix B](#)).

5.1 LIQUID NITROGEN SPILL AND/OR RELEASE

Notify a trained on-duty ERT Member via MGIO Radio.

Oxygen deficiency may be present in the vicinity of a major cryogenic accident. Cold gas will displace ambient air including oxygen. Cryogenics can liquefy oxygen in the air, so all sources of ignition shall be removed from the area if it is safe to do so.

1. Leave the area immediately.
2. Never exit the area through a vapor cloud. If you find yourself in a vapor cloud, hold your breath until you are out of the cloud.

DID ANYONE COME IN CONTACT WITH MATERIAL?

YES

NO

Go To [2.4a](#)

1. Thoroughly ventilate the area.
2. In case of dewar rupture, evacuate the area.
3. Close open valves if possible.
4. Clear area until flow stops.
5. An Oxygen Detector can be used to test the air before re-entering.

1. Notify an IC (see [Appendix A](#)).
2. Notify Base Camp.

6.0 POWER LOSS

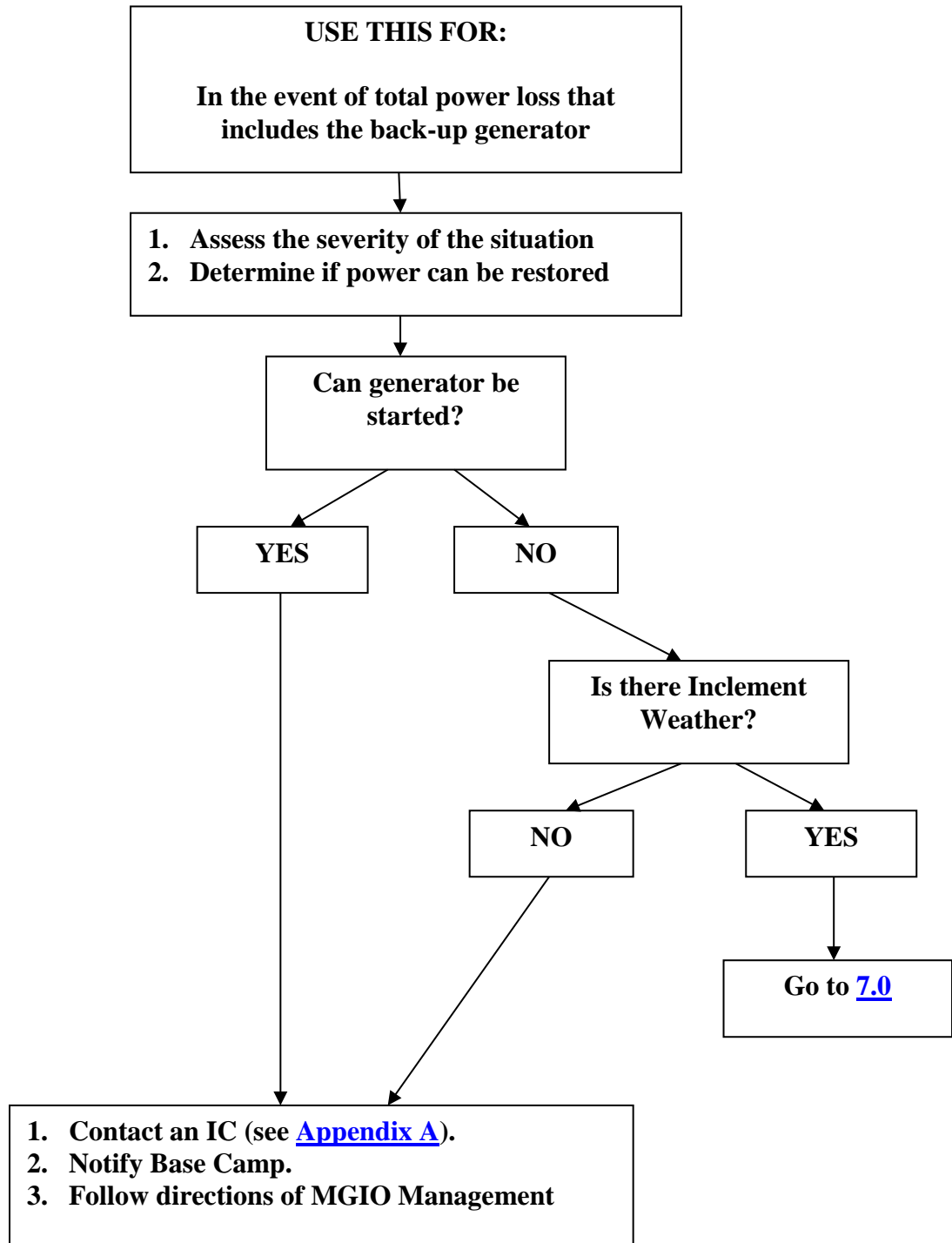

7.0 INCLEMENT WEATHER

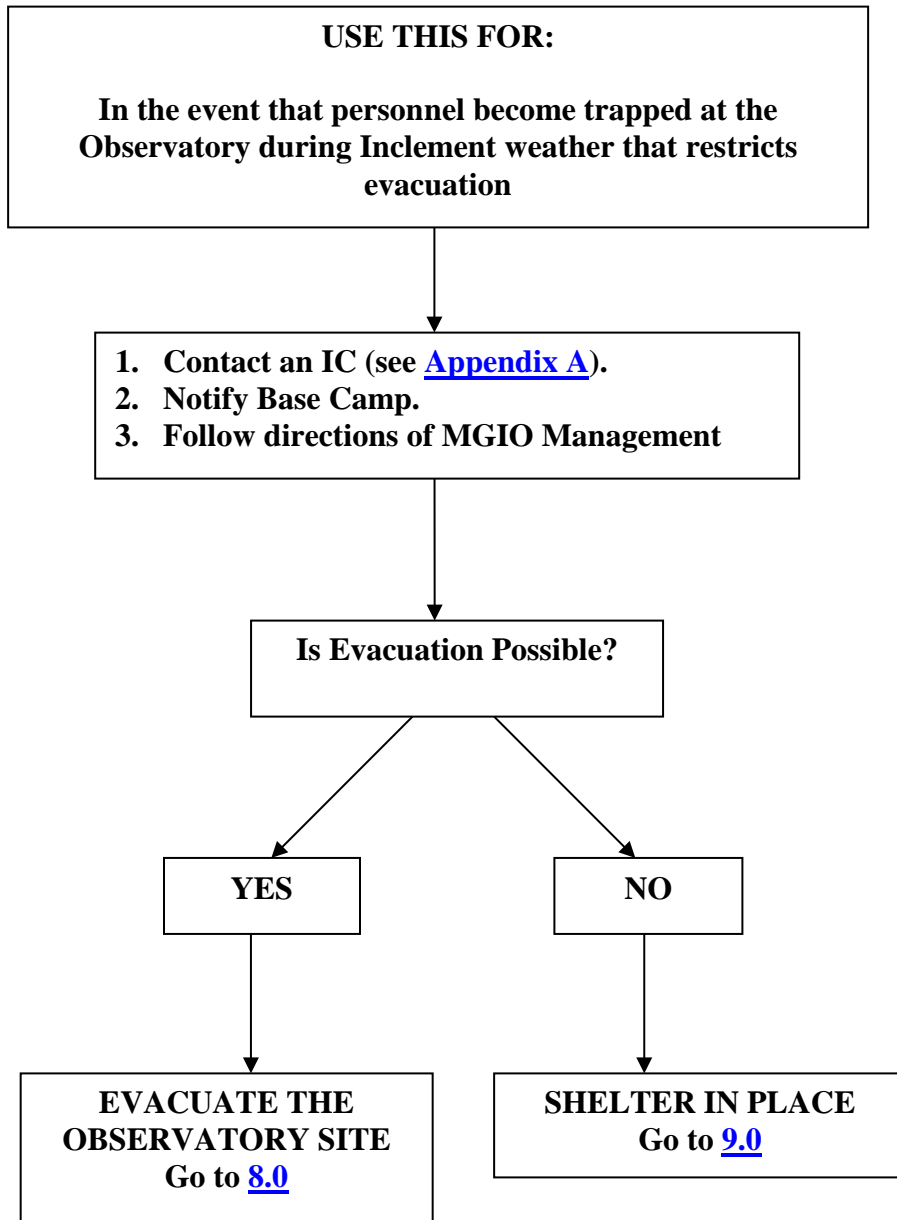

8.0 EVACUATION PROCEDURES

GUIDELINES

1. Only and IC or Forest Service orders evacuation of MGIO site. IC shall notify all persons on site of evac.
2. Evacuation consists of those measures necessary to remove endangered persons from the threatened areas. Evacuation may be undertaken simultaneously with other emergency conditions.
3. If the main access road or the dirt portion of SR366 is blocked, we are permitted to evacuate using the FS 507 road. In the extremely rare scenario where both are blocked, hiking to a safe area may be necessary.
4. At certain times of the year, helicopter airlift operations may not be viable due to low air density at higher altitudes.
5. The MGIO access road will normally be used to evacuate Observatory personnel (maps [Appendix E](#))

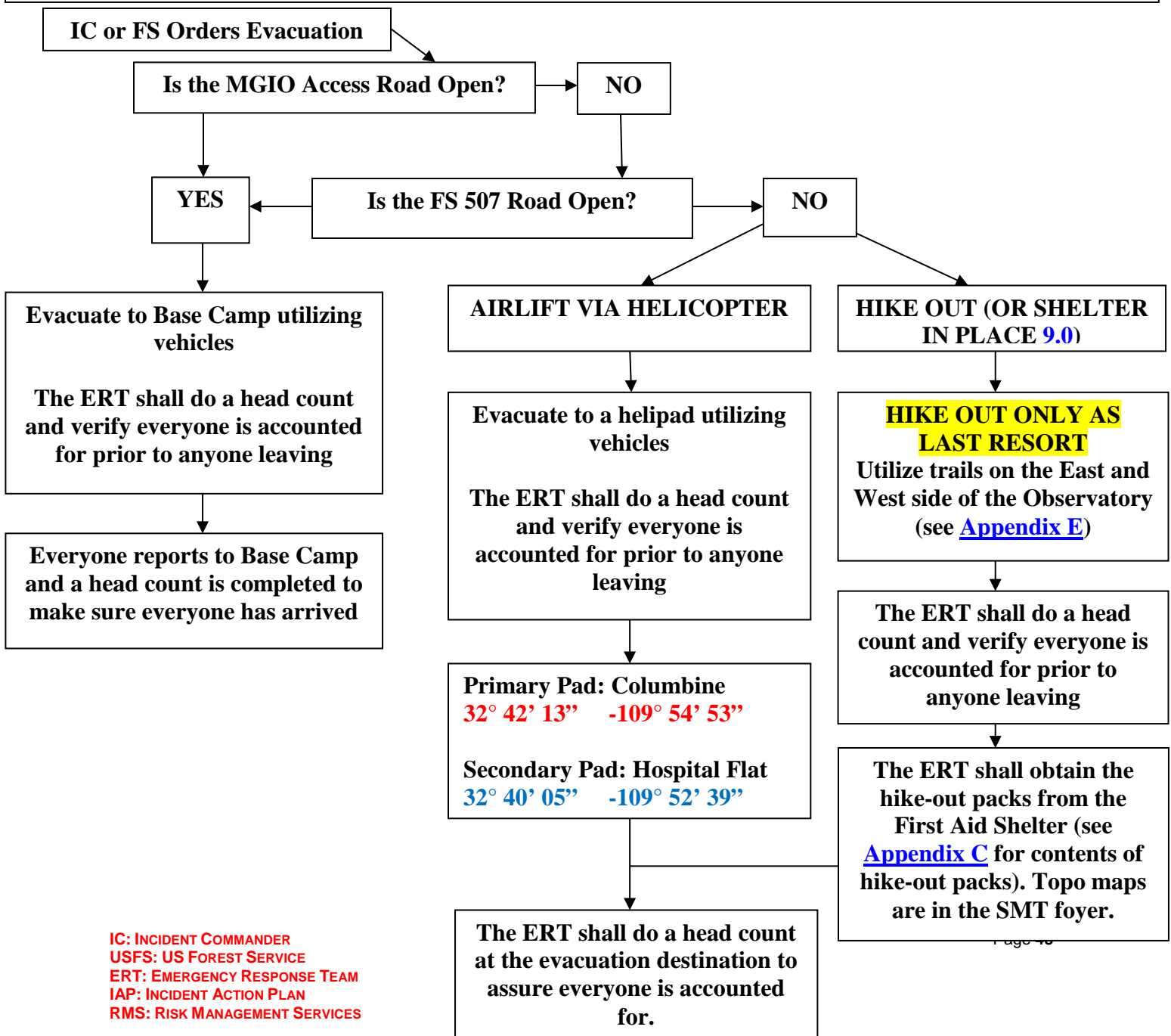

IC: INCIDENT COMMANDER
 USFS: US FOREST SERVICE
 ERT: EMERGENCY RESPONSE TEAM
 IAP: INCIDENT ACTION PLAN
 RMS: RISK MANAGEMENT SERVICES

9.0 SHELTER IN PLACE PROCEDURES

GUIDELINES

1. Only the IC or Forest Service can order a site-wide shelter-in-place. IC shall notify all persons.
2. The LBT is the designated shelter in place location
3. The LBT will have enough supplies and water for 10 people for 7 days (**Accurate?**)

IC ORDERS SHELTER-IN-PLACE
ALL PERSONNEL ARE TO REPORT TO THE LBT
The ERT shall do a head count and verify everyone is accounted for

ASSIGNMENTS

1. The ERT shall assign responsibilities to individuals for the duration of the time in the shelter
2. Food and water will be rationed to accommodate the anticipated time the shelter in place operation will be

THE EMRGENCY OPERATIONS CENTER (EOC)

1. The EOC will continue to work to evacuate the personnel from the area
2. The EOC will continue to work at supplying the personnel with food and water is possible
3. In the event that there is a forest fire, the EOC will notified the Forest Service of the personnel still at the observatory

10.0 WORKPLACE VIOLENCE

GUIDELINES

Threats or Acts of Violence are defined as conduct against persons or property that is sufficiently severe, offensive or intimidating to alter the condition of District employment, or to create a hostile, abusive or intimidating work environment for one or more District employees.

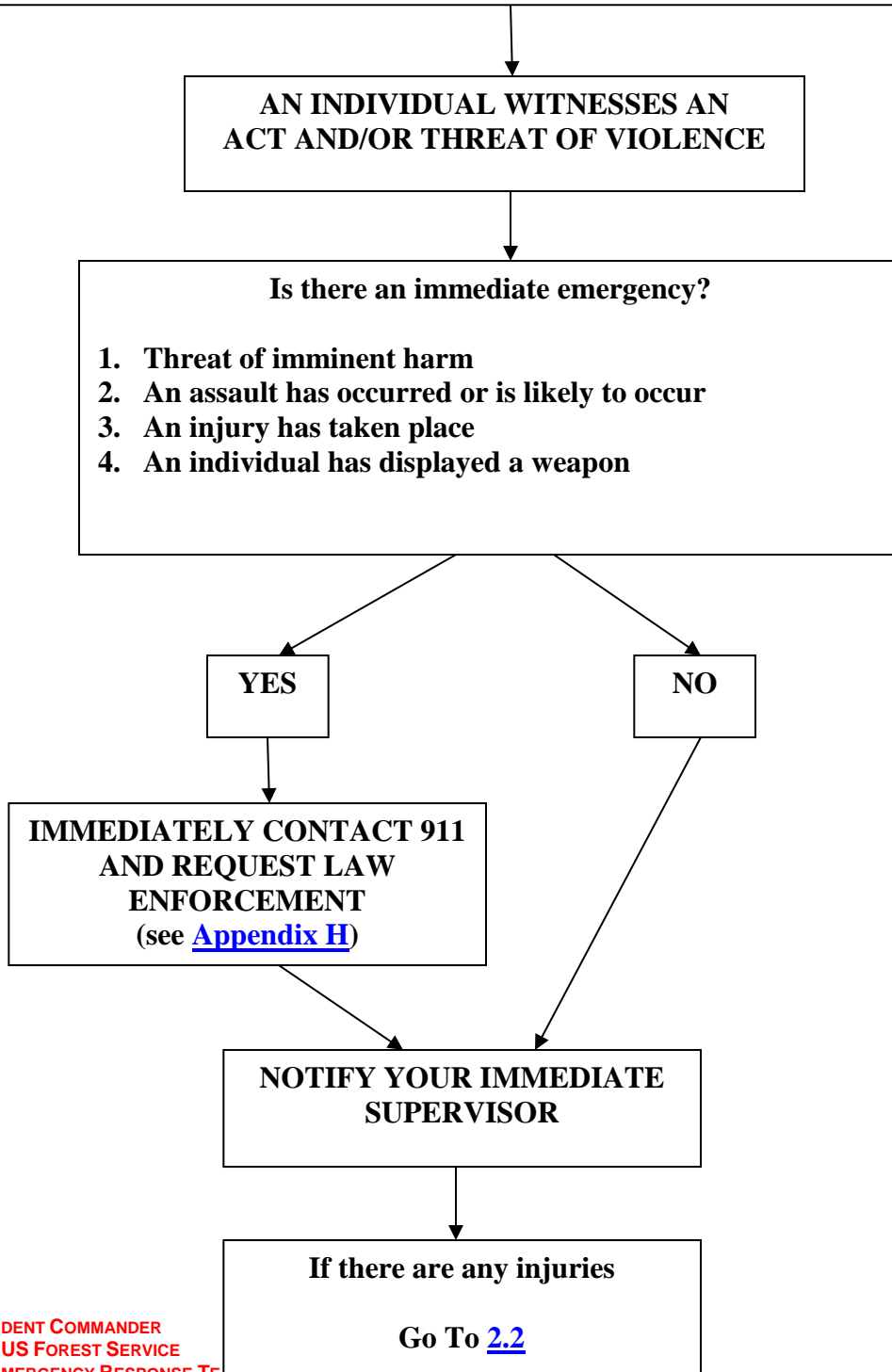

11.0 TRAINING REQUIREMENTS

ALL EMPLOYEES

All employees will be trained on:

1. Accessing the Emergency Response Contingency Plan procedures
2. Initiating communication and alarm systems
3. Fire and explosion response
4. SDS location and use
5. Recognizing hazards and how to initiate the ERT.
6. Evacuation procedures,
7. Shelter in place operations
8. Location of helicopter pads

EMERGENCY RESPONSE TEAM (ERT) MEMBERS

ERT members will be trained on the following in addition to above:

1. The Emergency Response Contingency Plan procedures.
2. Basic first aid; to include:
3. Bleeding control
4. Bandaging
5. Splinting
6. C-Spine and back stabilization and packaging
7. Basic shock treatment
8. Recognize possible medical/physical/physiological issues in people on the mountain
9. CPR with AED
10. Medical evacuation vehicle driving procedures
11. Train personnel on moving a sick or injured person down the mountain during inclement weather conditions using the medical evacuation vehicle
12. Proper use of extinguishers
13. How to recognize unsafe operations that could cause a fire and how to proactively mitigate unsafe operations
14. Understanding the importance of securing heating appliances like ovens
15. Safety Data Sheets (SDS) location and use
16. Utilizing proper PPE
17. Hazmat spill containment and clean-up procedures following SDS guidelines
18. Reporting requirements and procedures for chemical spills
19. Spill Prevention Countermeasures & Control (SPCC)
20. Generator Use

EMERGENCY OPERATIONS CENTER (EOC)

EOC staff members will be trained on the following in addition to above:

1. EOC Guidelines and Procedures
2. Basic NIMS Command Procedures

12.0 EMERGENCY OPERATIONS CENTER (EOC)

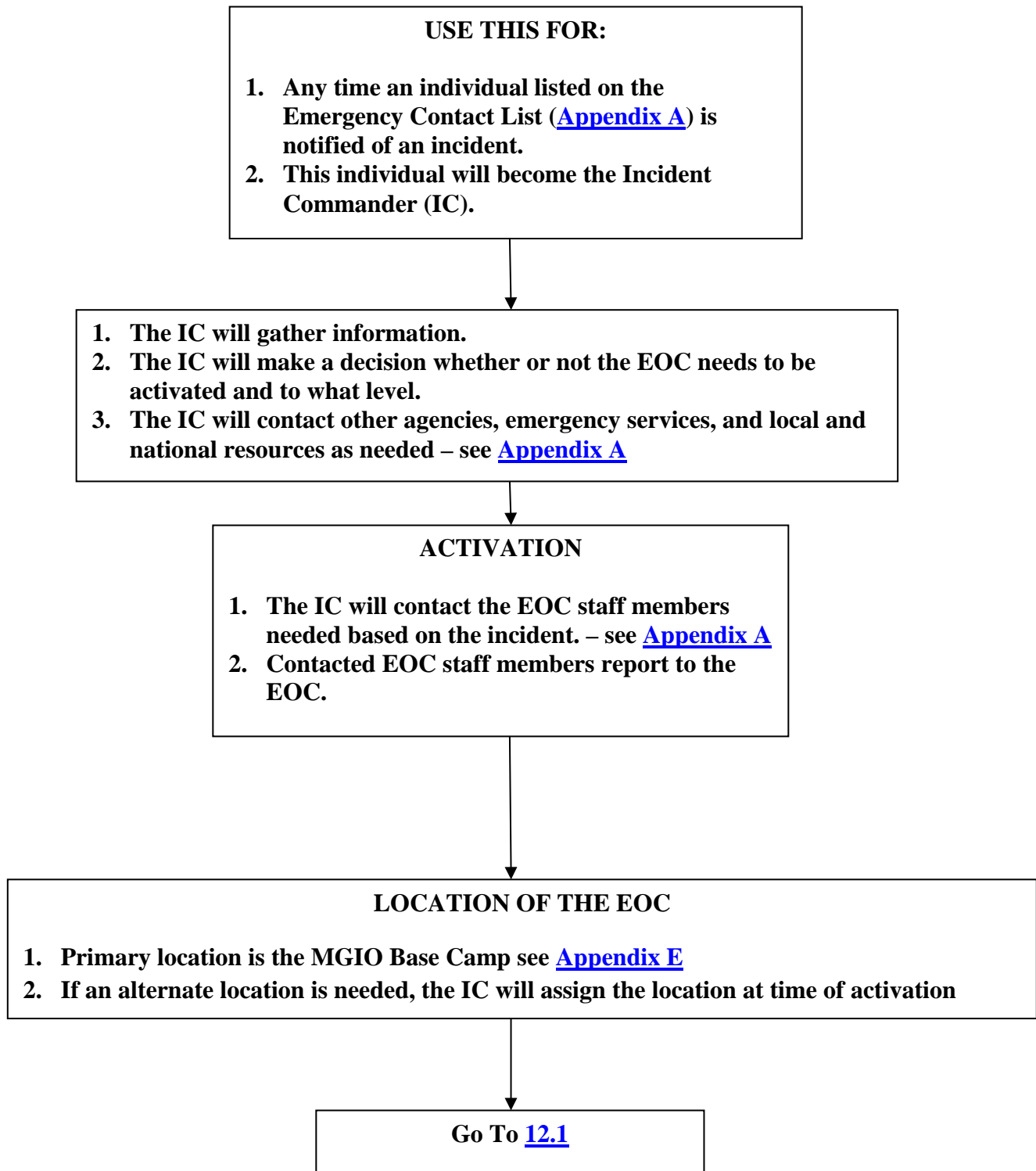

12.1 EOC ACTIVATION

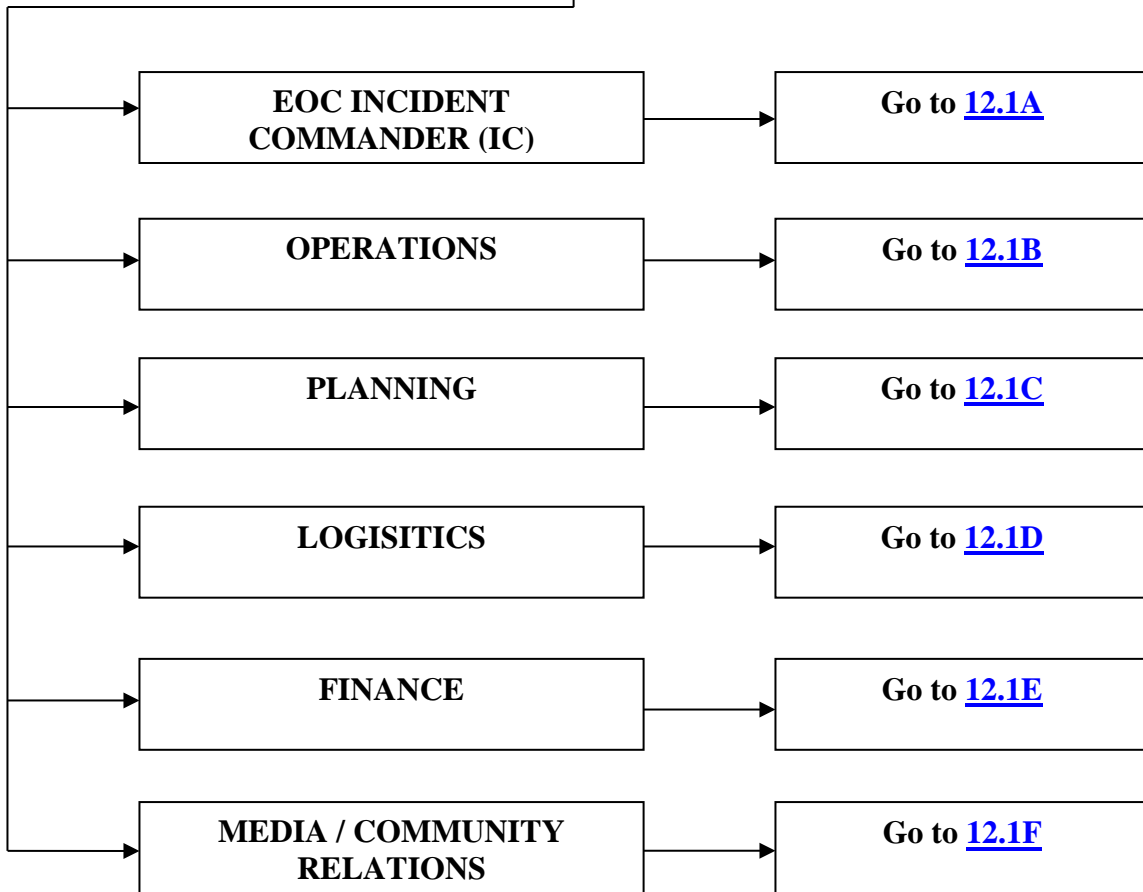
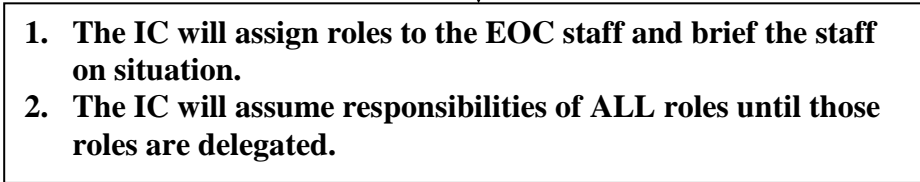
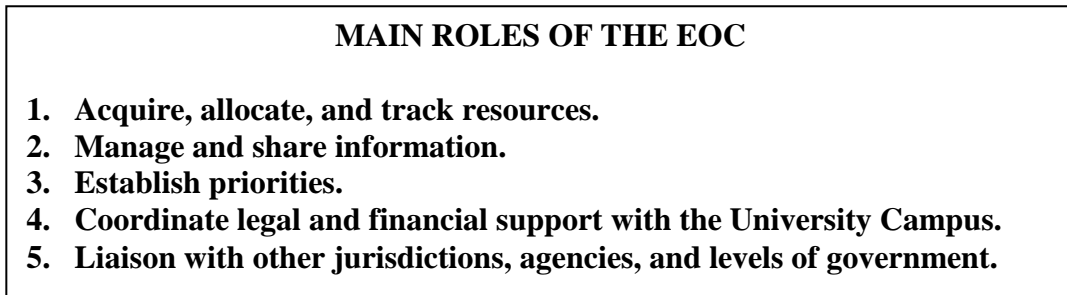

12.1A EOC INCIDENT COMMANDER (IC)

ROLES AND RESPONSIBILITIES

1. Has authority and responsibility to direct all EOC activities.
2. Is in charge of the EOC and all EOC staff and personnel.



JOB FUNCTIONS

1. Activates the EOC.
2. Determines location of the EOC – Main location is Base Camp. Incident command post can be established at any location (including command post).
3. Contacts EOC staff and has them report to EOC. – see [Appendix A](#)
4. Briefs EOC staff.
5. Assigns functions, responsibilities, and work duties to the EOC staff.
6. Determines overall goals and responsibilities of the EOC.
7. Approves and authorizes implementation of incidents action plan.
8. Approves requests for additional resources.
9. Authorizes release of information to staff, public, and media.
10. Follows up with EOC staff to ensure progress.
11. Ensures all EOC staff is keeping a recorded log of their actions/work.
12. Determines when and who the EOC will be deactivated.
13. Ensures all reports are completed and appropriately filed. Report Requirements are found in [Appendix B](#).

12.1B OPERATIONS CHIEF

ROLES AND RESPONSIBILITIES

1. Reports to the IC.
2. Is in responsible for the management of all operations directly applicable to the primary mission of the incident



JOB FUNCTIONS

1. Obtain briefing from the IC.
 - a. What the situation/incident is.
 - b. What resources have been assigned to the incident?
 - c. What resources are needed?
2. Develops operations portion of the Incident Action Plan (IAP; see [Appendix L](#)).
 - a. Priorities.
 - b. Goals.
 - c. Communications.
 - d. Logistical needs.
 - e. Assign resources.
3. Supervises Operations and makes adjustments as needed and based on input from Planning and Logistics.
4. Makes recommendation to the IC on when resources can be released.
5. Attend Section Chief Meetings.
6. Provides up to date briefings to IC.

12.1C PLANNING CHIEF

ROLES AND RESPONSIBILITIES

1. Reports to the IC.
2. Is responsible for the collection, evaluation, dissemination, and use of information about the development of the incident and status of resources.
3. Provides information that is needed to IC and other Section Chiefs to understand the current situation, predict probable course of incident events, and prepare alternative strategies and control operations for the incident.



JOB FUNCTIONS

1. Obtain briefing from the IC.
 - a. What the situation/incident is.
 - b. What resources have been assigned to the incident?
 - c. What resources are needed?
2. Supervises preparation of the Incident Action Plan (IAP; see [Appendix L](#)). Provides detailed information concerning.
 - a. Situation status.
 - b. Situation predictions.
 - c. Communication capabilities.
 - d. Weather conditions.
 - e. Resource availability.
 - f. Environmental impact.
3. Assembles information on alternative strategies.
4. Provides periodic predications on incident potential.
5. Maintains incident status board.
6. Plans, schedules, and coordinates Section Chief Meetings.
 - a. IAP development
 - b. On-going assessment and evaluation of progress
7. Provides up to date briefings to IC.

12.1D LOGISTICS CHIEF

ROLES AND RESPONSIBILITIES

1. Reports to the IC.
2. Is responsible for ordering and logging resources needed for the incident based on the Incident Action Plan (IAP; see [Appendix L](#)).

JOB FUNCTIONS

1. Obtain briefing from the IC.
 - a. What the situation/incident is.
 - b. What resources have been assigned to the incident?
 - c. What resources are needed?
2. Assists in developing the Incident Action Plan (IAP). Provides detailed information concerning.
 - a. Resources currently assigned to the incident.
 - b. Resources still available.
3. Based on the IAP and length of the incident, orders and tracks
 - a. Supplies
 - b. Food
 - c. Personnel
4. Provides resource information and time logs to Finance.
5. Attend Section Chief Meetings.
6. Provides up to date briefings to IC.

12.1E FINANCE CHIEF

ROLES AND RESPONSIBILITIES

1. Reports to the IC.
2. Is responsible for all financial and cost analysis aspects of the incident.

JOB FUNCTIONS

1. Obtain briefing from the IC.
 - a. What the situation/incident is.
 - b. What resources have been assigned to the incident?
 - c. What resources are needed?
2. Assists in developing the Incident Action Plan (IAP; see [Appendix L](#)).
Provides detailed information concerning:
 - a. Provides input in all IAP and predictions prepared by the Planning Chief
 - b. Finance summary on labor, material, and service costs.
 - c. Cost predictions based on operational goals and resource needs.
 - d. Ensures proper documentation is received and accurate for labor, supplies, materials, and services
 - e. Ensures timesheets for personnel are received and accurate
3. Attend Section Chief Meetings.
4. Provides up to date briefings to IC.

12.1F MEDIA AND COMMUNICATIONS CHIEF

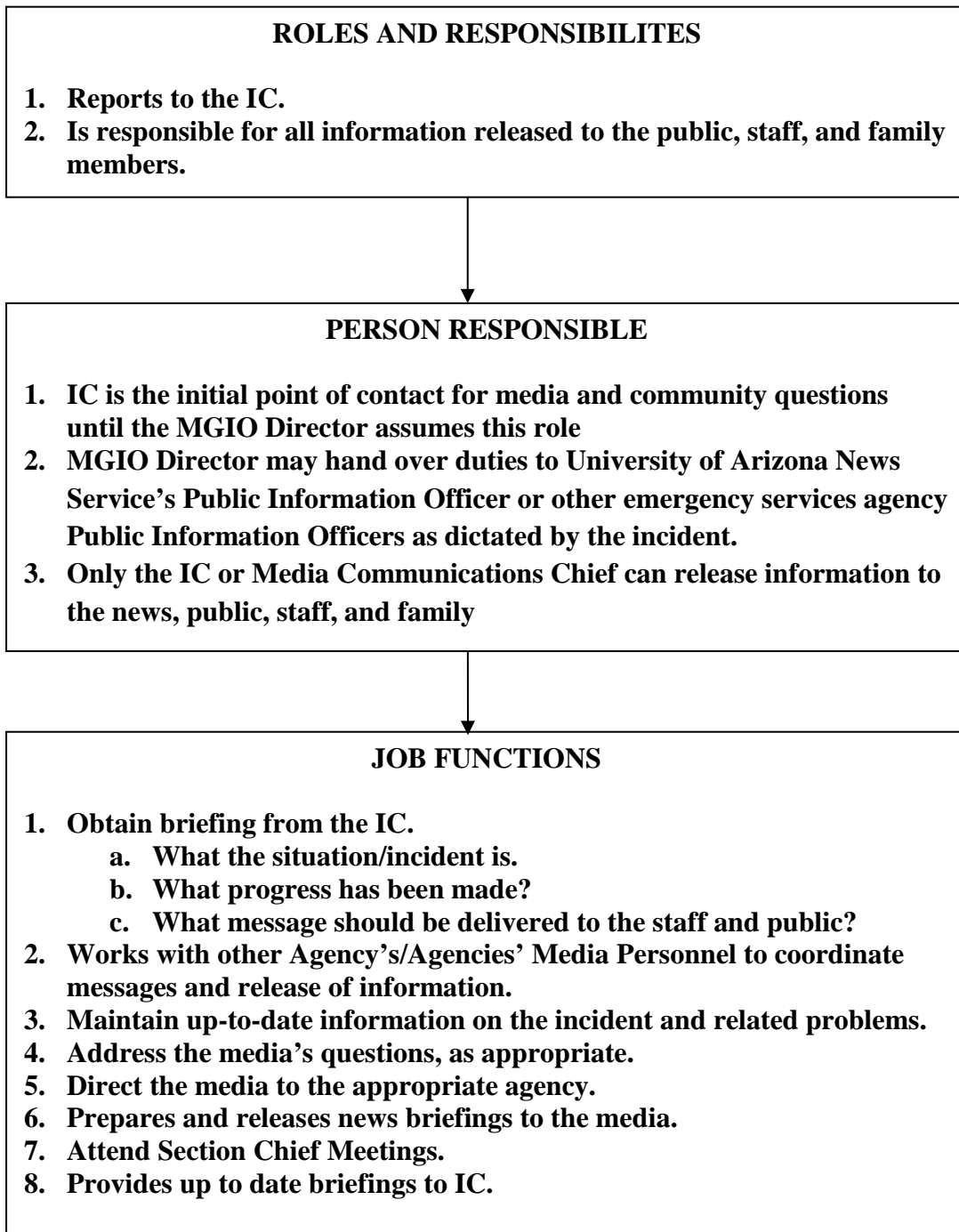

IC: INCIDENT COMMANDER
USFS: US FOREST SERVICE
ERT: EMERGENCY RESPONSE TEAM
IAP: INCIDENT ACTION PLAN
RMS: RISK MANAGEMENT SERVICES

APPENDIX A: CONTACT LISTS

IC: INCIDENT COMMANDERS

PRIMARY INCIDENT COMMANDER:

Eric Buckley
Director
Mt. Graham International Observatory

Work Phone: (928) 428-2739
Cell/Mobile Phone: (928) 965-3004
Address: 1515 15th Place
Safford, AZ 85546

SECONDARY INCIDENT COMMANDER (1):

R. Shane Olsen
Operations Superintendent
Mt. Graham International Observatory

Work Phone: (928) 428-2739
Cell/Mobile Phone: (928) 965-3102
Address: 1175 E. Olsen Acres
Safford, AZ 85546

SECONDARY INCIDENT COMMANDER (2):

Jeffrey S. Kingsley
Associate Director
Steward Observatory

Home Phone: (520) 886-6412
Work Phone: (520) 626-3527 UA
Cell Phone: (520) 289-0869
Address: 3687 N. Cam. Rio Soleado
Tucson, AZ 85718

EMERGENCY RESOURCES (1):

Steven C. Holland
Assistant Vice President
UA Department of Risk Management Services

Home Phone: (520) 749-9287
Work Phone: (520) 621-1556
(520) 621-1790
Cell Phone: (520) 349-4273
Address: 12561 E Sonoran Ridge Dr.
Tucson, AZ 85749

EMERGENCY RESOURCES (2):

Herbert N. Wagner
Director of Occupational &
Environmental Health and Safety
UA Department of Risk Management Services

Home Phone: (520) 881-5448
Work Phone: (520) 621-7691
Cell Phone: (520) 349-0984
Address: 2918 E. Croyden
Tucson, AZ 85716

EMERGENCY RESOURCES (3):

Jeffrey G. Christensen
Hazardous Waste Supervisor
UA Department of Risk Management and Safety

Home Phone: (520) 408-4895
Work Phone: (520) 621-5861
Cell Phone: (520) 349-2187
Address: 1300 W. Roller Coaster
Tucson, AZ 85704

UNIVERSITY OF ARIZONA RESOURCES

UNIVERSITY OF ARIZONA POLICE DEPARTMENT (24 HOURS) (520) 621-8273
WADE BOLTINGHOUSE Work Phone: (520) 621-5190 (928) 348-0001
Cell Phone: (928) 965-9325

UNIVERSITY OF ARIZONA - GILA VALLEY

Operations Superintendent (Shane Olsen) 928-428-2927 928-965-3102
Base Camp 928-428-2739
Administrative Associate (Barbara Abril) 928-428-2739 928-651-5905
Director (Eric Buckley)..... 520-621-6524..... 520-245-3551
Maintenance Shop (Base Camp)..... 928-428-2927
MGIO Duty Person 928-965-3100
University Police Department MGIO 928-348-0001

UNIVERSITY OF ARIZONA - TUCSON

Associate Director, Steward Observatory 928-626-3527 520-886-6412 520-289-0869
Director, Steward Observatory 520-621-6524 520-245-3551
Public Information Officer, UA New Services 520-626-5620 765-404-5959
(Chris Sigurdson)

LARGE BINOCULAR TELESCOPE (LBT) MANAGEMENT

LBT Emergency Contact Lists:

- [M004s00302](#), Tucson Office Emergency Contact List
- [M004s00303](#), Observatory Summit Emergency Contact List
- [M004s00304](#), Tucson Remote Observing Room Emergency Contact List

Christian Veillet, Director 520-349-4576 (cell)
David Carroll, Safety Manager 520-419-3106 (cell)
Patrick Hartley, Observatory Manager 920-254-6993 (cell)
Michael Wagner, ASST. Obs. Manager 520-488-4452 (cell)

LBT Emergency Phone (wakes the mountain manager) 928-828-8001
LBT Observatory Main Number 520-626-1466 (office)
LBT Remote Observing Room (Tucson) 520-626-4335

VATICAN ADVANCED TECHNOLOGY TELESCOPE (VATT) MANAGEMENT

Paul Gabor, Vice Director 520-621-6043 (office)
Taras Golota, Telescope Manager 520-414-8025 (cell)

Chris Johnson, Network, Telecom	520-229-7617 (cell)
Gary Gray, General Maintenance Supervisor	928-965-8634 (cell)
VATT Main Number	520-626-6365 (office)

**ARIZONA RADIO OBSERVATORY (ARO) SUBMILLIMETER TELESCOPE
(SMT) MANAGEMENT**

Alyson Ford	520-621-2495 (office)
Bob Moulton	520-621-4328 (office)
Tom Folkers	520-909-1113 (cell)
Jeff Kingsley	520-289-0869 (cell)
SMT Main Number	520-621-4328 (office)

STATE AND NATIONAL AUTHORITIES

Arizona Department of Environmental Quality (ADEQ)

Call in the following order until a person has been contacted:

- * ADEQ General Number 800-234-5677
- * Emergency Response 602-771-2330 – leave report
- * 24-hour Emergency After Hours 602-390-7894
- * Department of Public Safety (DPS) 602-223-2000
- * DPS *On-Duty D.E.Q. Haz-Mat Officer* 602-771-4106

National Response Center (NRC) 800-424-8802

The report to the above organizations must include:

- * Name and telephone number of reporter;
- * Name and location of facility;
- * Time and type of incident (e.g., release, fire);
- * Name and quantity of materials or material involved to extent known;
- * The extent of injuries, if any; and
- * The possible hazards to human health, or the environment, and any clean-up procedures that are in progress.

CHEMTREC 800-424-9300 ext#1

For specific information on chemicals in an emergency (always see the SDS, as well). This service is paid for by chemical and product manufacturers, and is offered for end users at no cost. MGIO can call for information on any chemical and CHEMTREC will attempt to assist.

EMERGENCY SERVICES AND OTHER AGENCY RESOURCES

U. S. FOREST SERVICE - SAFFORD RANGER DISTRICT

District Ranger Office928-428-4150
 Safford District Ranger (Curtis Booher) 928-348-1974 928-215-9330
 Fire Management Officer (Everett Phillips)..928-428-4150 928-719-1595
 Fire and Safety Program Manager.....520-991-7844
 HAZ-MAT Office (Leo Holley).....520-306-6542
 Asst HAZ-MAT Officer (Everett Phillips)....928-428-4150 928-719-1595
 Public Affairs Office (Heidi Schewel)520-749-7720
 Forest Fire Dispatcher (24 Hour Dispatcher) 520-202-2710 (during fire season)

GRAHAM COUNTY SHERIFF'S OFFICE (dispatch)928-428-3141 (928-428-0808)

GRAHAM COUNTY EMERGENCY RESPONSE UNIT

Emergency Response Director (Terry Cooper)..... 928-428-3250 (w) 928-651-6505 (h)
 County Engineer (Michael Bryce).....928-428-0410 (w)...928-485-7001 (h)
 Emergency Response Deputy Director (Brian Douglas)928-428-1962 (w)...928-965-8921 (h)

ARIZONA DEPARTMENT OF TRANSPORTATION.....928-428-4735 (main)
 Highway Ops Tech Supply (Brad Smith).....928-965-7537 (cell)
 Highway Ops Tech 4.....928-965-7536 (cell)

FEDERAL CORRECTIONS INSTITUTION.....520-886-1295 (main)
 Facilities Management (Ben Fajardo)928-348-3609

ARIZONA BIBLE CAMP (Church of Christ)520-886-1295

COLUMBINE CABIN OWNERS ASSOCIATION.....928-485-2224

RESPONSE CONTRACTORS (Under State Contract)

Southwest Hazard Control (Jim Santino)520-622-3607 ext.129

AUTHORIZATION OF INCIDENT COMMANDERS

February 6, 2015

Arizona Department of Environmental Quality
Office of Waste Programs
2005 North Central Avenue
Phoenix, AZ 85004

To Whom It May Concern:

The individuals listed below are authorized as emergency coordinators for any problems or situations involving hazardous materials at/for the Mt. Graham International Observatory (MGIO). They are authorized to direct and commit, if necessary, all available resources to implement the Mt. Graham International Observatory Emergency Response Contingency Plan on behalf of The University of Arizona.

Primary Emergency Coordinator:

R. Shane Olsen, Observatory Operations Supervisor, MGIO

Secondary Emergency Coordinators:

Buell T. Jannuzi, Director, Steward Observatory, UA & Acting Director, MGIO
Jeffrey S. Kingsley, Associate Director, Steward Observatory, UA

Emergency Resources:

Steven C. Holland, Assistant Vice President for Risk Management Services, UA
Herbert N. Wagner, Director of Occupational & Environmental Health and Safety, UA
Frank R. Demer, Health Safety Officer, UA
Jeffrey G. Christensen, Hazardous Waste Supervisor, UA

Sincerely,

(Signed original on file)

Kimberly A. Espy, Ph.D.
Senior Vice President for Research

APPENDIX B: REPORTING REQUIREMENTS

All contact numbers found in [Appendix A](#)

Situation	NOTIFY							
	Obs Mgmt	UAPD	UA-RMS	Forest Service (USFS)	GCSO	UA PIO	ADEQ	NRC
Medical Emergency	X	X	X		X			
Chemical Spill	X	X	X	DR/HM/PA		X	X	X
Structure Fire	X	X	X	DR/PA/FD	X	X		
Forest Fire	X	X	X	DR/PA/FD	X			
Communication Failure	X	X			X			
Extreme Inclement Weather	X	X						
Workplace Violence	X	X	X		X			

UAPD: Tucson dispatch

UA-RMS: Risk Management Services: Injury/Incident Reporting through UAccess

Forest Service: **DR:** District Ranger Office, **HM:** HazMat Office, **PA:** Public Affairs Office, **FD:** Fire Dispatch

GCSO: Graham County Sheriff Office dispatch.

UA PIO: Public Information Officer

ADEQ: Arizona Department of Environmental Quality

NRC: National Response Center

NOTE:

[Appendix A:](#) Contact Lists contains point of contact and phone numbers for each group.

APPENDIX C: EQUIPMENT

Medical kits and oxygen are maintained in each building at the Observatory site. A 4x4 Evacuation Vehicle, equipped with basic first aid supplies, Oxygen, AED and radio communication, is available on site to transport incapacitated persons to helicopter pick-up points or to a medical facility. The medical kit in the transport vehicle is composed of blood pressure and heart/lung monitoring equipment, oxygen supply, backboards, cervical collars, splints and basket stretchers.

MGIO Emergency Evacuation Vehicle

1. Keys are located in UAPD Building
2. Vehicle is Located:
 - a. Summer: Next to UAPD Building
 - b. Winter: Inside utility building
3. Vehicle contains an AED, oxygen, first aid kits and supplies and a stretcher.
4. Instructions are on vehicle dash on how to operate. Walkthroughs are always available upon request to demonstrate.



EMERGENCY EVACUATION VEHICLE START UP CHECK LIST

To Start the Vehicle:

1. UNPLUG THE SHORE LINE ELECTRICAL CORD: drivers side on the box
2. TURN OFF THE BLOCK HEATER: switch is behind driver's seat
3. TURN MASTER SWITCH ON: below driver's seat, left hand side
4. TURN IGNITION SWITCH TO ON: let the "WAIT" light cycle 2 or 3 times before cranking over
5. START ENGINE: if engine does not want to start, recycle through the "WAIT" light again

To Use the Back:

1. TURN ON SWITCH LABELED "MODULE DISCON": center console; this will put 110 AC power to the back

NOTE: WHEN PARKED, SET THE PARKING BRAKE AND LEAVE IT SET; this will put the engine at a high idle keeping everything charged properly

Instructions for Winter Access: Note that the Utility building and the vehicle bay where the Emergency Vehicle is stored during winter months can now be accessed with the Master site key (AA EN A/A1). It is no longer required to break the glass to enter the garage bay.



Automatic External Defibrillators (AED)

There are 5 AEDs:

- 1 LBT Level 2, Kitchen
- 1 LBT Level 5, Auxiliary Control Room
- 1 UAPD Building
- 1 Evacuation Vehicle
- 1 MGIO Front Office Bookshelf
- 1 UAPD Police Vehicle



LBT Equipment Locations

For a complete list of LBTO equipment, see the LBTO Emergency Action Plan (EAP) M004s00310. Below is a high-level summary:

Equipment	Locations
Oxygen Tanks, Medical	Level 1: Front Desk & Outside Lab 116 Level 2: Main Hallway & Kitchen by Television. Level 5, 6, 7 & 9: Outside Elevator UAPD Building and Evac. Vehicle
First Aid Kits (includes blood oxygen sensors)	Level 1: Front desk rear cabinet (portable) Level 1: High Bay Level 2: Kitchen Level 5: Outside Aux. Control Room UAPD Building and Evac. Vehicle (portable)
ERCP Binders	Level 1 Lobby (in podium) Level 2 Kitchen (by First Aid Kit on wall) Level 5 Aux Control Room (on top shelf to right)
Satellite Phone	Bonnie's Desk near Window (Sat phone plus case/car charger with instructions; please keep phone charging)
Back Brace with C-spine (note: evacuation vehicle has a stretcher inside)	Level 2 (kitchen) Level 5 (by first aid kit)

VATT Equipment Locations

IC: INCIDENT COMMANDER
 USFS: US FOREST SERVICE
 ERT: EMERGENCY RESPONSE TEAM
 IAP: INCIDENT ACTION PLAN
 RMS: RISK MANAGEMENT SERVICES

Reserved.

SMT Equipment Locations

Reserved.

Utility Building Equipment Locations

Reserved.

UAPD Building Equipment Locations

Reserved.

Base Camp Equipment Locations

Reserved.

VEHICLE EQUIPMENT ASSIGNMENTS

The equipment and assignments listed below are for the purpose of covering emergency response actions. The University will provide operators for their equipment.

<u>Operator - Title</u>	<u>Equipment Description</u>	<u>Vehicle #</u>
Primary/Emergency Coordinator	Ford Expedition 4x4	8094
Maintenance Mechanic, Lead	Chevy 3500 1 ton PU 4x4	4702
Maintenance Mechanic	Chevy 3500, 1 ton PU 4x4	8040
Maintenance Mechanic	2½ yd Case Articulated Loader	Model W24C
	John Deere Grader	Model #570B
	John Deere Grader	Model#772A
Administrative Associate	MGIO Dispatcher/Communication Center	

Reserve Personnel:

Maintenance Supervisor – Shop
 Maintenance Mechanic
 Custodial Crew (4)

Reserve Equipment:

- 2 ¾ ton, 4wd, Pickup Trucks
- 1 1 ton 4wd, Pickup Truck
- 1 Case Articulated 2½ yard Loader (Model W24C)
- 1 John Deere Articulated 4 yard Loader (Model 644G)
- 1 John Deere Articulated 4 yard Loader (Model 644H)
- 1 Case Backhoe (Model 580-E)
- 1 Drott – 30 ton hydraulic crane – all terrain
- 1 Freightliner Semi-Tractor / Low Boy Trailer
- 1 Kenworth Semi-Tractor / Water Tender (3,150 gallons)
- 1 Peterbilt Dump Truck 10 wheeler
- 1 Peterbilt Semi-Tractor / Water Tender (3,150 gallons)
- 1 2,500 Gallon Gray-Water Tanker
- 1 250 kW Mobile Generator Set
- 1 Mat Tracks Truck #3874

FIRE, SPILL, FIRST AID TRANSFER AND HIKE OUT GEAR PACKS

Emergency response equipment lockers are maintained at the Mt. Graham International Observatory (MGIO). The firefighting gear is in a locker painted red and labeled "Emergency Response Locker" located in the Maintenance Storage building. The spill response gear is in a large circular white polyethylene container located in the Utility building. They contain:

Firefighting Gear

Canteens
Shovels
McCloud (hoe/rake tool)
Pulaskies (specialty axe)
Head Lanterns
Swatters
First Aid Kits

Spill Response Gear

Polyethylene Pails (5 gal)
with locking lids and handles
Acid Spill Pillows
Vermiculite, Medium Grade
Shovels (non-sparking)
Yellow Hazard Tape
Tyvek Suits
Latex Gloves
Neoprene Gloves
Chemical Splash Goggles
Over-boots
Plastic Bags
pH Paper
Pink PIG mats (good for all chemical types)

"Mini" spill kits will be kept in the vicinity of any chemical storage areas to immediately control spills.

In addition to the above supplies, the MGIO Service Truck, operated by the assigned duty-person, is outfitted with the following equipment:

Canteens, Shovel, McCloud, Pulaskie, Fire Extinguisher, Bolt Cutters, Hard Hats, Flashlights, First Aid Kit, Chain Saw and a Basic Tool Kit.

Maintenance of Gear shall be in accordance with Appendix F.

FIRST AID TRANSFER BAG INVENTORIES

<u>UAPD Building Transfer</u>		<u>Blue Jump Bag 1</u>	
Viraguard	1 Bottle	Burn Dressing	4
Cotton Rounds	100	Sam Splint	2
Band Aids	3 boxes	Stethoscope	2
Conforming Bandage	3 Boxes	Blood Pressure Cuff	1
Bag Valve Mask	1	Cold Pack	7
Non-Rebreather	20	Heat Pack	7
2x3	18	5x9 Dressing	2
4x4	2 Boxes	Triangle Bandage	7
5x9	2	Trauma Dressing	6
Nasal Cannulas	22	Emergency Blanket	2
Trauma Dressing	6	White Tape	1
Alcohol Preps	60	Vomit Bag	2
Electric Suction	1	Co Flex	2
Mast Pants	1	Safety Glasses	2
Bandage Roll	2	Handheld Suction	1
Bandage Tape	1	<u>Green Airway Bag 1</u>	
Triangular Bandage	7	Oxygen Tank "D"	1
AED w/asprin	1	Regulator for D Tank	1
(LifePak500, SN 13355169)		Bag Valve Mask	1
Blankets	4	Pocket Mask	1
Hot Packs	7	Non Rebreather Mask	4
Cold Packs	7	Nasal Cannula	4

Head Immobilizers	6	Handheld Suction	2
Rubber Gloves Lg	2	Pulse Ox	1
Rubber Gloves Med	1	Head Immobilizer	1
Red Bags	1 Box	C Collar	1
Co-Flex	2	<u>AED Lifepack500</u>	2
Sharps Container	2	In Ambulance #8310	1
Dyna Flo Regulator	1	(SN14008002)	
Digital Blood Pressure	1	Office (SN13355169)	1
Glucose/Glucometer	2	<u>Training Aids</u>	
Speed Clip	6	CPR Promt Adult Torso	5
K.E.D. Board	1	Adult heads for above	6
Spine Boards	2	CPR Promt Infant	2
Basket Stretcher	1	Resusci Junior	1
Oxygen Tank "J"	1	Resusci Baby	1
Regulator for J Tank	1	Lifepak 500T Trainer	1
Oxygen Tank "D"	3	(SN 19441 F-020-025	
OPA's	1 Box	EMR 2 nd edition Books	5
IV Start Kits	4		
IV Catheters	9		
IV Drip Tubing	1		
Medical Illustrations, Charts	3		

“Hike-Out” Pack Inventory (2 located in UAPD Building)

<u>Red Backpack</u>	<u>1</u>	<u>Blue Backpack</u>	<u>1</u>
Compass	1	Compass	1
Air Horn	1	Flashlight	1
Flare	2	Canteen	1
Water Proof Matches	2 Boxes	Water Tabs	1 Box
Ponchos	2	Fire Starter Sticks	2 Boxes
Emergency Blanket	2	Water Proof Matches	2 Boxes
Water Tabs	1 Box	Flare	2
Fire Starter Sticks	1 Box	Snake Bite Kit	1
MRE's	3	Ponchos	2
Flashlight	1	Emergency Blanket	2
Topo Map	1	First Aid Kit	1
First Aid Kit	1	Air Horn	1
Canteen	1	Insect Bite Kit	3
		Water Tabs	1 Box

APPENDIX D: COMMUNICATIONS SYSTEMS

VOICE & DATA COMMUNICATIONS

Location	Equipment or System	Primary or Secondary	Comment
MGIO Site-Wide	MGIO VHF Base Station & Vehicle Radios	Primary	Will reach GCSO 1 or 2. Building radios will work on back-up generator power.
	MGIO VHF Handheld Radios	Primary	Limited transmission power. May not reach GCSO 1 or 2, depending on location.
	MGIO VOIP Phone System (Microwave)	Primary	Will work on back-up generator power. Provider is Valley Telecom.
	MGIO Internet Connection (Microwave)	Primary	Can work independent of microwave VOIP system. Provider is Valley Telecom.
LBT Specific	Satellite Phone, Handheld	Secondary	LBTO Front Desk, keep charging.
	Emergency “Wake the Manager” Phone Line	Secondary	Emergency phones (3) are located at the front desk and in rooms 220 and 228. 900 MHz transmission system provided by Valley Telecom.
	Personal Mobile Phones	Secondary	Limited Coverage
	Wi-Fi Calling via 4G Hotspot	Secondary	Normally off to avoid RF interference. Must be powered on. In Level 1 Asst. Mgr. office.
	Wi-Fi Calling via 4G Repeater	Secondary	Normally off to avoid RF interference. Must be powered on. Level 2 conference room.
	UHF Indoor Radios (short-range)	Local Only	Limited range outside of building.
SMT	Emergency Phone Line	Secondary	900 MHz transmission system provided by Valley Telecom.
VATT			
UAPD Hut	Satellite Phone, Handheld	Secondary	Stored inside the hut, keep charging.

MGIO Telephone System

MGIO Telephone System																								
Revision: December 2011 (Reviewed & Approved April 2019 E. Buckley & Valley Telecom)																								
MGIO Site																								
Color Description:																								
yellow =	LBT	Tucson Area Code -- 520																						
tan =	VATT	Safford Area Code -- 928																						
green =	SMT	Bonita Area Code -- 928																						
blue =	UAPD																							
purple =	MGIO																							
Valley Telephone Microwave -- 18 GHz																		900 MHz Radio						
Telephone Model #				Tucson Exchange (520)	Tucson Exchange (520)	Tucson Exchange (520)	Tucson Exchange (520)	Tucson Exchange (520)	Tucson Exchange (520)	Tucson Exchange (520)	Tucson Exchange (520)	Tucson Exchange (520)	Safford Exchange (928)	Safford Exchange (928)	Safford Exchange (928)	Safford Exchange (928)	Bonita Exchange (928)	Bonita Exchange (928)	Bonita Exchange (928)	Bonita Exchange (928)	Bonita Exchange (928)			
No Cord	17208	T7316	digital extension	19	4	626-1466	626-3039	626-9258	626-1583	621-4328	626-5343	626-6365	626-6523	621-5190	428-4288	428-9768	348-0001	348-4768	828-1191	828-1192	828-1193	828-0132	828-3384	828-0001
LBT	2	3	5	19	4	x	x	x	x	x	x	x	x	x	x	x	x	x	x	x	x	x	x	x
VATT	2	3	5	19	4																			
SMT	8	1	9	1	1																			
UAPD	1	1	1	1	1																			
MGIO	1	1	1	1	1																			
Total	2	29	3	35	6																			
Notes:																								
1) * LBT analog lines: 2 - elevators, 1 - security & HVAC control system, 1 - fax																								
2) LBT -- Tucson and Safford lines -- one telephone number to roll over to an available open line.																								
3) Bonita lines coming up the 900 MHz link are distributed onsite via copper bypassing the Norstar Key System (i.e., a POT system) using non-electronic phones.																								
4) Pooled lines are for outgoing calls only -- they should not ring! Priority for pooled lines -- (#1) Tucson, (#2) Safford, (#3) Bonita.																								
MGIO Base Camp																								
Quest Demark - MGIO Base Camp																								
Tucson Exchange (520)											Safford Exchange (928)													
621-8077	621-8650	428-2739	428-2927	428-2854	348-0206	348-0001	348-4768																	
fax	Office	Office	Shop	fax	fax	fax	Site																	
MGIO Base Camp							UAPD					pooled												
Billing Information:																								
for phone service		Organization		Account Number / Unit																				
		LBT		490925 OPSP																				
		VATT		434420 OPS																				
		SMT		111138 SMT																				
		UAPD		211062 UAPD																				
		MGIO (Base Camp)		111132 SAF																				
Each organization pays for their phone services (month to month) -- MGIO (Base Camp) pays for the three pooled lines. Any long distance charges on the pooled lines will be rebilled to the appropriate parties.																								
Leased phone equipment charges are billed according to the number (percentage) of phone extensions -- no change from current practice.																								
Telephone System 2011.xlsx																								

See File for Full Version:



Telephone System
2011.xlsx

IC: INCIDENT COMMANDER
USFS: US FOREST SERVICE
ERT: EMERGENCY RESPONSE TEAM
IAP: INCIDENT ACTION PLAN
RMS: RISK MANAGEMENT SERVICES

MGIO RADIO SYSTEM

The MGIO has three types of VHF frequency modulated (FM) radio equipment: base stations, mobile vehicle radios and portable hand held units.

The UAPD and the Observatory are equipped with two-way radios for internal communication as well as with external agencies such as the Arizona Department of Transportation, the Graham County Sheriff's Office, and the U.S. Forest Service. MGIO and the Observatories store these base station and h radios in the buildings. Mobile units are permanently installed in MGIO vehicles.

Radio units from the Observatory and the Forest Service will be exchanged and available for effective coordination during any emergency response action.

The primary channel (channel #1) for the MGIO two-way VHF radio system relies on a repeater located at Heliograph Peak, an electronic site in the Pinaleño Mountains. The repeater allows communication between the MGIO site and the Base Camp located in the Gila Valley – east of the mountain range. MGIO maintains a secondary channel (simplex channel #3) for local operations and construction. There is no repeater for channel #3 and thus the communication distances are limited.

In addition, an emergency channel is provided for communication to other Steward Observatory crews in the Tucson area via a repeater system located on Mt. Hopkins -- south of Tucson in the Santa Rita Mountains (channel #13, 14). The Fred Lawrence Whipple Observatory, a division of the Smithsonian Astrophysical Observatory, operates this repeater. To access the Mt. Hopkins repeater one must be on the west slope of the Pinaleño Mountains.

Typically site operations require traffic clearance on the state highway, SR-366, during the winter snow season. Radio contact with the Arizona Department of Transportation (ADOT - channel #6) is warranted to prevent collisions with snow removal equipment. In certain emergency situations such as spotting a forest fire, radio contact with the U.S. Forest Service (USFS – channel #8) is necessary.

VHF RADIO FREQUENCIES USED BY THE OBSERVATORY

Channel #	Assigned To:	Description	RX	FREQUENCY (MHz)		ENC (PL Tone)	Priority
				DEC (PL Tone)	TX		
1	MGIO Repeater (Heliograph Peak)	MGIO RPT	154.430	(114.8)	151.295	(114.8)	Priority
2	MGIO Repeater Bypass	MGIO TA	154.430	(114.8)	154.430	(114.8)	
3	MGIO Simplex Communications	MGIO LOC	155.955	(114.8)	155.955	(114.8)	
4	Graham County Sheriff #1	GCSO 1	155.715	(141.3)	153.995	(156.7)	
5	Graham County Sheriff #2 (Heliograph)	GCSO 2	155.055	(114.8)	153.785	(167.9)	
6	ADOT Repeater (Heliograph Peak)	ADOT RPT	156.225	(103.5)	151.010	(118.8)	
7	ADOT Simplex Communications	ADOT LOC	156.120	(103.5)	156.120	(103.5)	
8	USFS Repeater Net (Heliograph Peak)	USFS RPT	169.600	none	170.525	(118.8)	
9	USFS Repeater Net (West Peak)	USFS WPK	169.600	none	170.525	(100.0)	
10	USFS Limited Range	USFS LOC	168.200	none	168.200	none	
11	USFS Fire Net	USFS NET	168.150	none	172.275	(118.8)	
12	Kitt Peak National Observatory	KPNO	164.350	none	164.350	(103.5)	
13	FLWO Repeater (Tucson Base)	SO-FLWO	169.925	(203.5)	169.050	(203.5)	
14	FLWO Repeater (SAO Ops)	FLWO	169.925	(114.8)	169.050	(114.8)	
15	State (Arizona Emergency)	STATE	154.280	none	154.280	none	
16	USA (National Emergency)	USA	155.475	none	155.475	none	
17	NWS - Weather Information (Safford)	NWS RPT	162.550	none	none	none	
18	Southwest Ambulance	SW AMB	155.175	(114.8)	155.175	(114.8)	

U.S. Forest Service Radio System:

Frequencies used by the Forest Service:

Channel #	Assigned To:	RX	Frequency (MHz)		(PL Tone)
			(PL Tone)	TX	
1	USFS Coronado Forest Net Simplex	169.600	none	169.600	none
2	USFS Repeater (Heliograph Peak)	169.600	none	170.525	(118.8)
3	USFS Repeater (West Peak)	169.600	none	170.525	(100.0)
4	USFS Air to Ground	171.425	none	171.425	none
	USFS Fire Net	168.150	none	172.275	(118.8)
10	Limited Range (Local)	168.200	none	168.200	none
15	MGIO Repeater (Heliograph Peak)	154.430	(114.8)	151.295	(114.8)

Graham County Sheriff's Department Radio System:

Frequencies used by the Graham County Sheriff's Department:

Channel #	Assigned To:	RX	Frequency (MHz)		(PL Tone)
			(PL Tone)	TX	
1	Graham County Dispatch #1	155.715	(141.3)	153.995	(156.7)
2	Graham County Dispatch #2	155.055	(114.8)	153.785	(167.9)

IC: INCIDENT COMMANDER
USFS: US FOREST SERVICE
ERT: EMERGENCY RESPONSE TEAM
IAP: INCIDENT ACTION PLAN
RMS: RISK MANAGEMENT SERVICES

APPENDIX E: SITE MAPS & SCHEMATICS

Note: Exhibit 1-8 are reserved (not in use).

MAPS

<u>Exhibit 9:</u>	Swift Trail Reference Road Markers
<u>Exhibit 10:</u>	Map of Southeastern Arizona
<u>Exhibit 11:</u>	Map of Pinaleno Mountains/Swift Trail
<u>Exhibit 12:</u>	MGIO Location/Site Plan
<u>Exhibit 13:</u>	MGIO Research Site Boundary
<u>Exhibit 14:</u>	MGIO Site Plan w/Building Numbers
<u>Exhibit 15:</u>	MGIO Utility Building, Water, and Propane Layouts
<u>Exhibit 20:</u>	Mt. Graham Regional Medical Center Location Map
<u>Exhibit 21:</u>	Helicopter Landing Map
<u>Exhibit 22:</u>	Building Evacuation Assembly Area Map
<u>Exhibit 23:</u>	Flammable Storage Tanks and Supply

SCHEMATICS

<u>Exhibit 16:</u>	MGIO Power Distribution System
<u>Exhibit 17:</u>	MGIO Propane Distribution System
<u>Exhibit 18:</u>	MGIO Water and Fire Protection Water Dist. Systems
<u>Exhibit 19:</u>	MGIO Diesel Fuel Transfer System

Exhibit 9: Swift Trail Reference Road Markers

Arizona Highway 366 (Swift Trail) provides access to within two miles of the Mt. Graham International Observatory (MGIO). Landmarks and mile posts are located along Swift Trail and are listed below:

<u>Location</u>	<u>Milepost Marker</u>	<u>Miles from Base Camp</u>
MGIO Base Camp	114.7	0
Marijilda Canyon Road Intersection	116.8	2.1
4,000' Elevation Marker	117.5	2.8
Coronado Forest Boundary	118.5	3.8
FR-861 Road Intersection (Heliport)	119.5	4.8
FR-667 Road Intersection – USFS Work Site (5,000' elevation)	120.4	5.5
Noon Creek crossing	121.0	6.2
FR-329 Road Intersection – Angle Orchard	121.4	6.4
Round the Mountain Trailhead turnout	121.5	6.5
6,000' Elevation Marker	123.3	8.3
Wet Canyon Bridge	123.6	8.6
Arcadia Campground	125.5	10.4
Cluff Dairy Turnout (Heliport)	126.2	11.0
7,000' Elevation Marker	126.6	11.4
Turkey Flat (old general store)	127.9	12.7
Twilight Campground Road Intersection	128.4	13.2
8,000' Elevation Marker	130.1	14.9
Lady Bug Saddle (8,508' Elevation)	131.0	15.8
Utility Corridor	132.1	16.9
Hagens Point (The Kitchen).....	133.3	17.9
9,000' Elevation Marker	134.5	19.1
Snow Flat Campground Road Intersection	135.2	19.8
Shannon Campground & Heliograph Peak Road Intersection	135.8	20.4
FR-507 Intersection (High Peak)	136.1	20.7
Swift Trail (Hwy 366) Main Gate	136.2	20.8
Treasure Park Road Intersection	137.0	21.6
Hospital Flat Campground (Alternate Heliport).....	137.2	21.8
Grant Hill Intersection	137.8	22.4
Grant Creek crossing	139.2	23.6
Cunningham Campground	139.9	24.3
Moonshine Creek crossing	140.6	25.0
Post Creek crossing	141.4	25.8
Ft. Grant Vista Overlook	141.8	26.2
MGIO - Emerald Peak Access Road Intersection	142.3	26.7
Old Columbine - Bible Camp Road Intersection (Heliport).....	143.2	27.6
Public Horse Corral	143.3	27.7
Soldier Creek Campground	143.7	28.1
Peters Flat	144.3	29.0
Chesley Flat	145.5	30.2
FR-287 Riggs Lake Road Intersection	147.5	32.2

Exhibit 10: Map of Southeastern Arizona

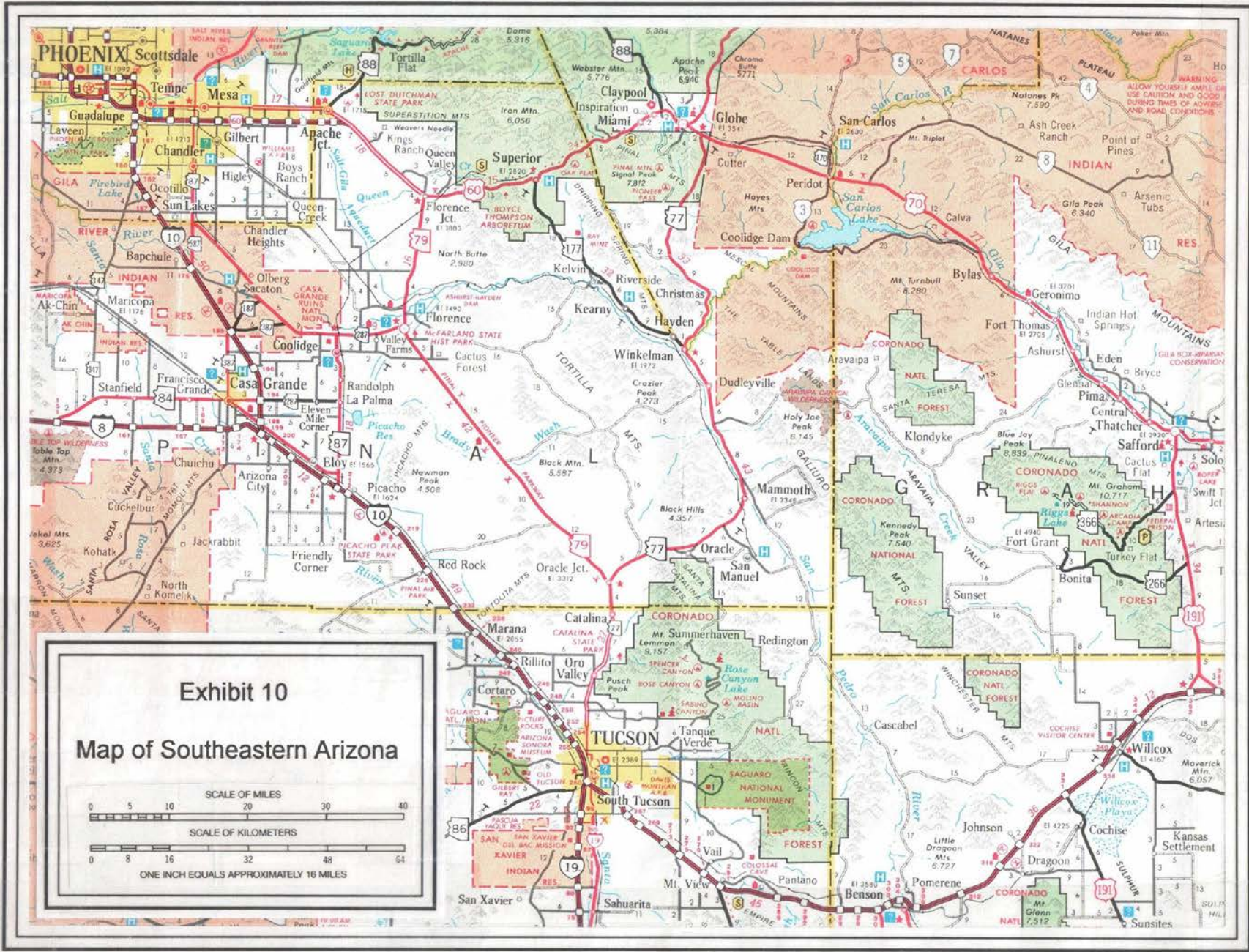

IAP: INCIDENT ACTION PLAN
RMS: RISK MANAGEMENT SERVICES

Exhibit 11: Map of Pinaleno Mountains/Swift Trail

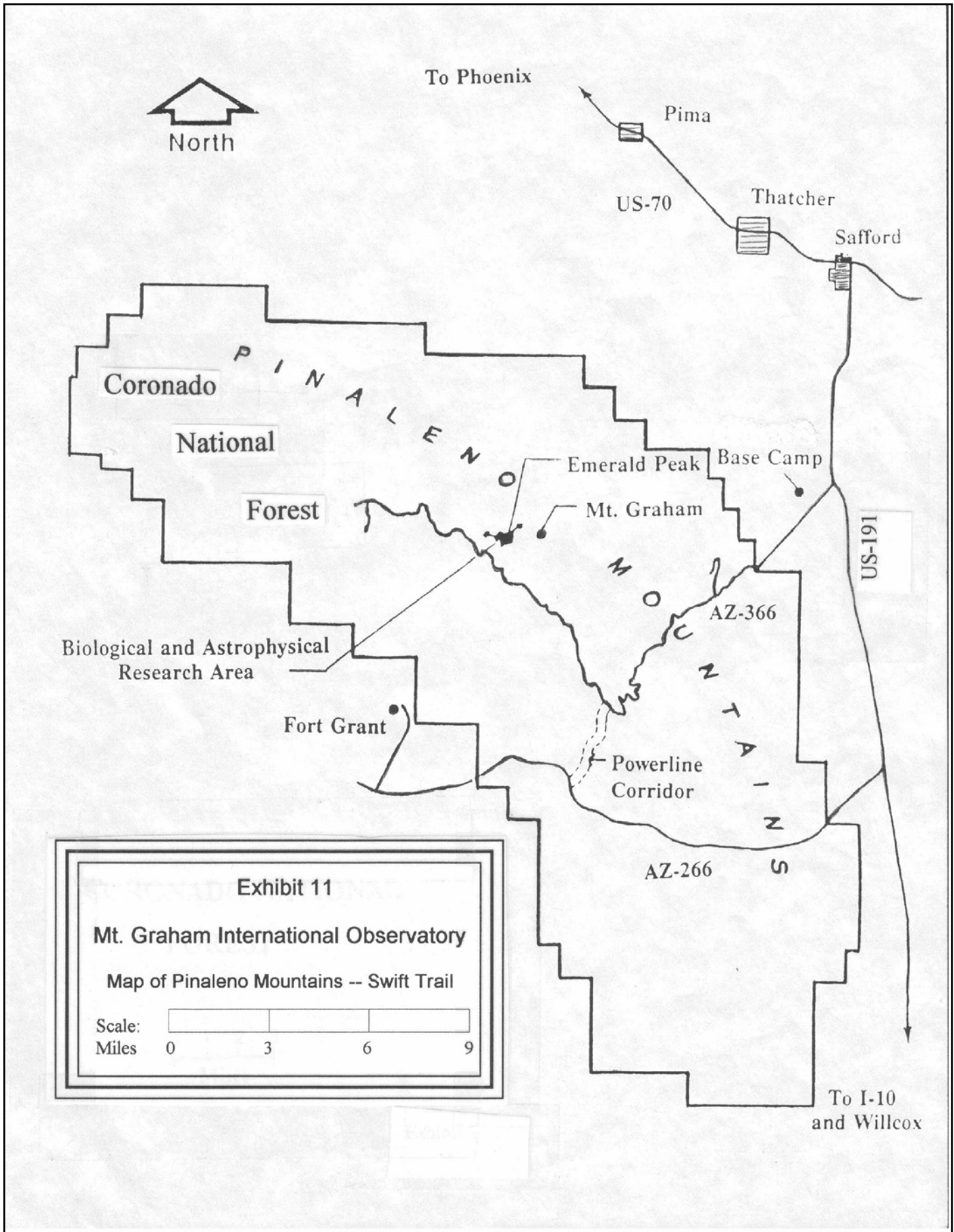

Exhibit 12: MGIO Location/Site Plan

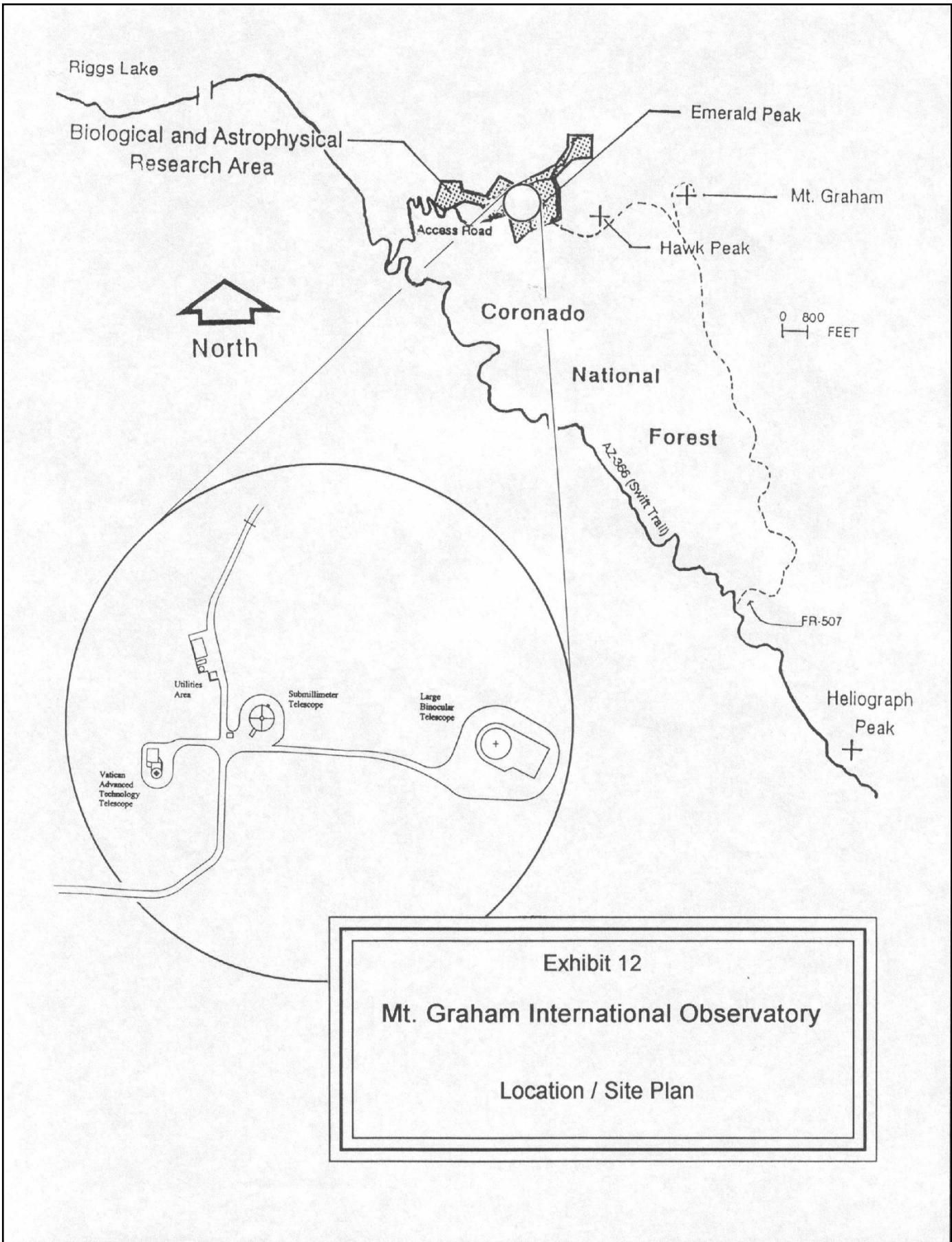

Exhibit 13: MGIO Research Site Boundary

Exhibit 13

Mt. Graham International
Observatory Research Site

Scale (feet):

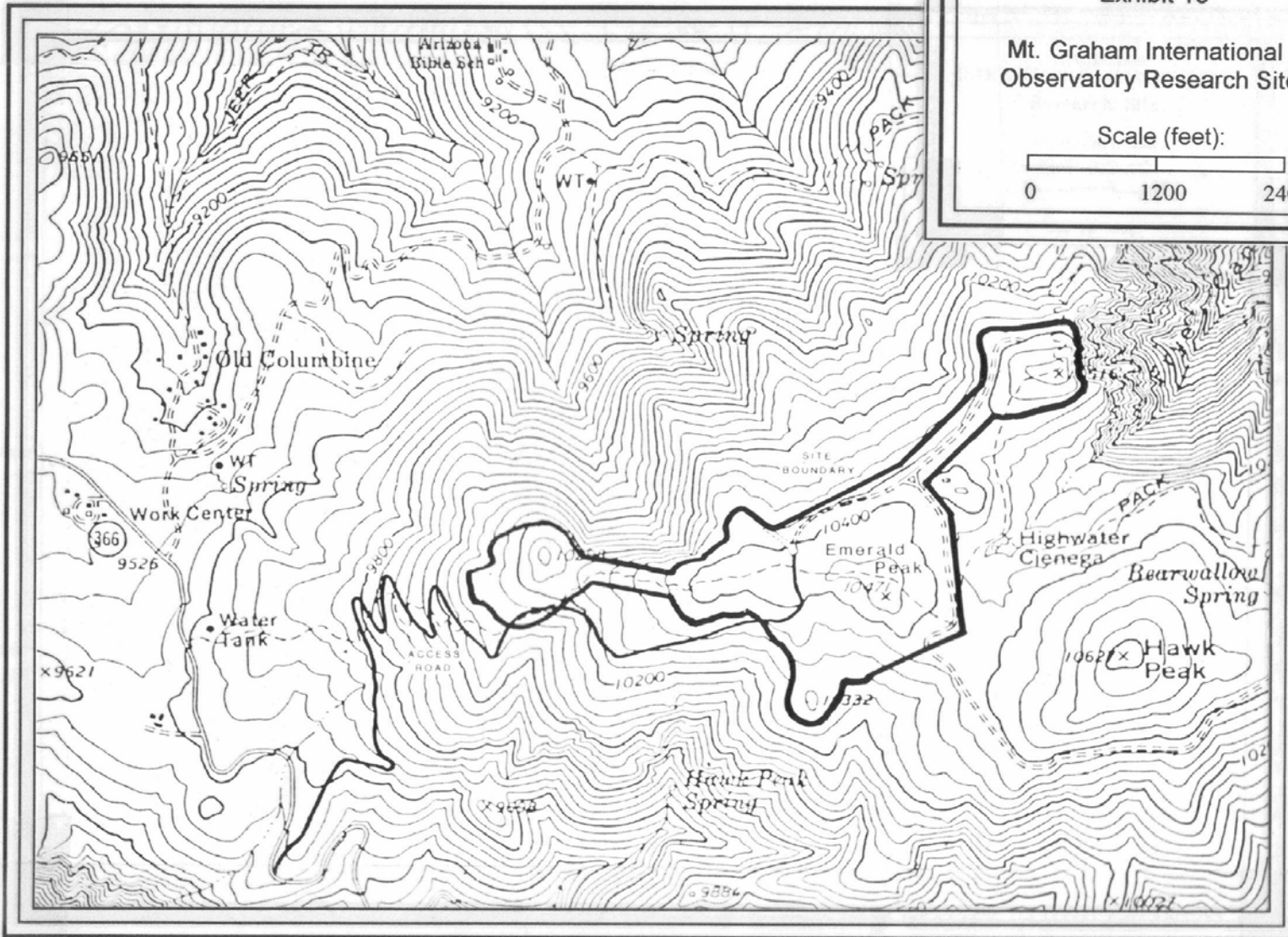
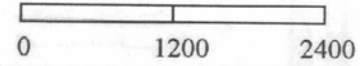

Exhibit 14: MGIO Site Plan w/Building Numbers

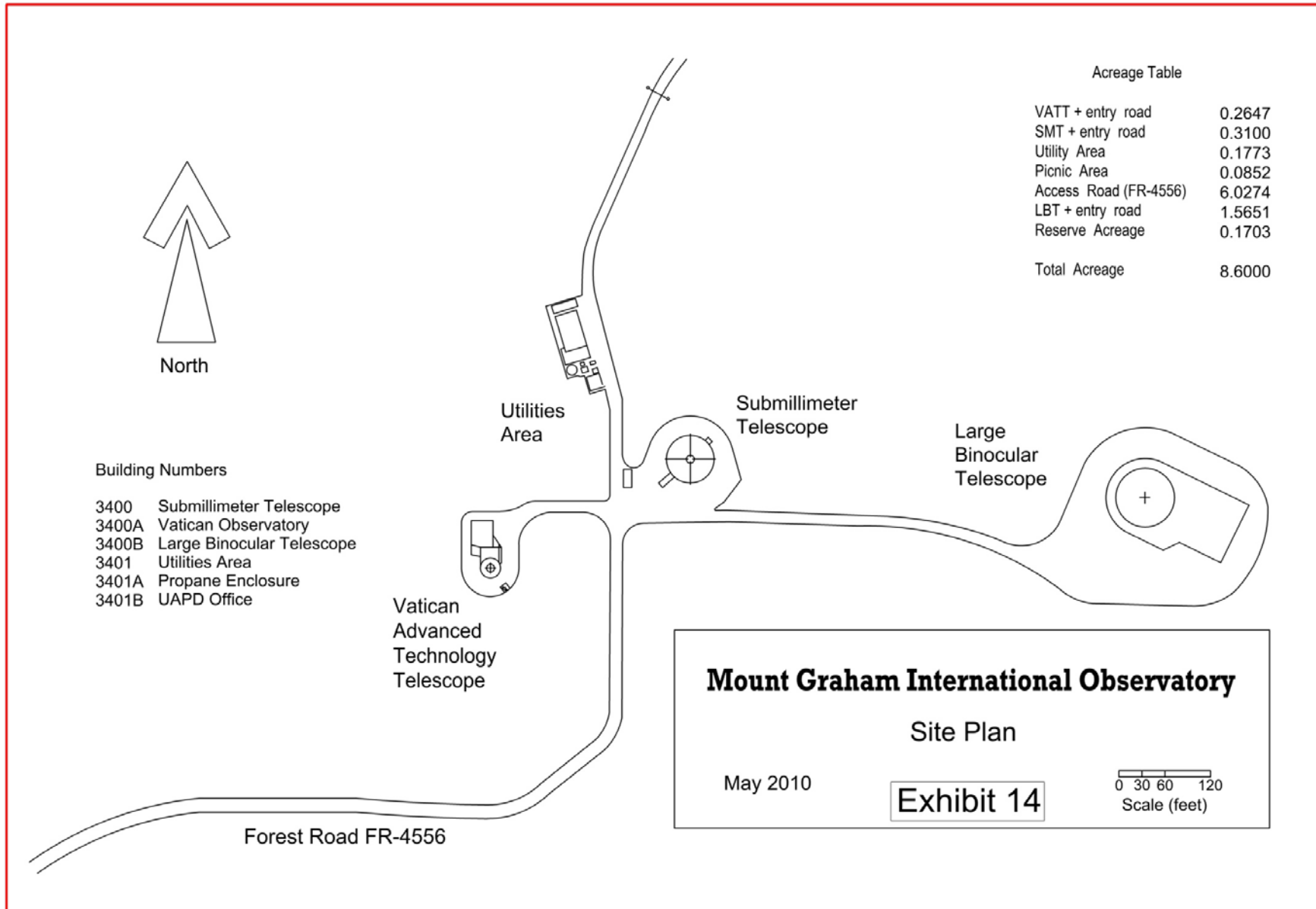
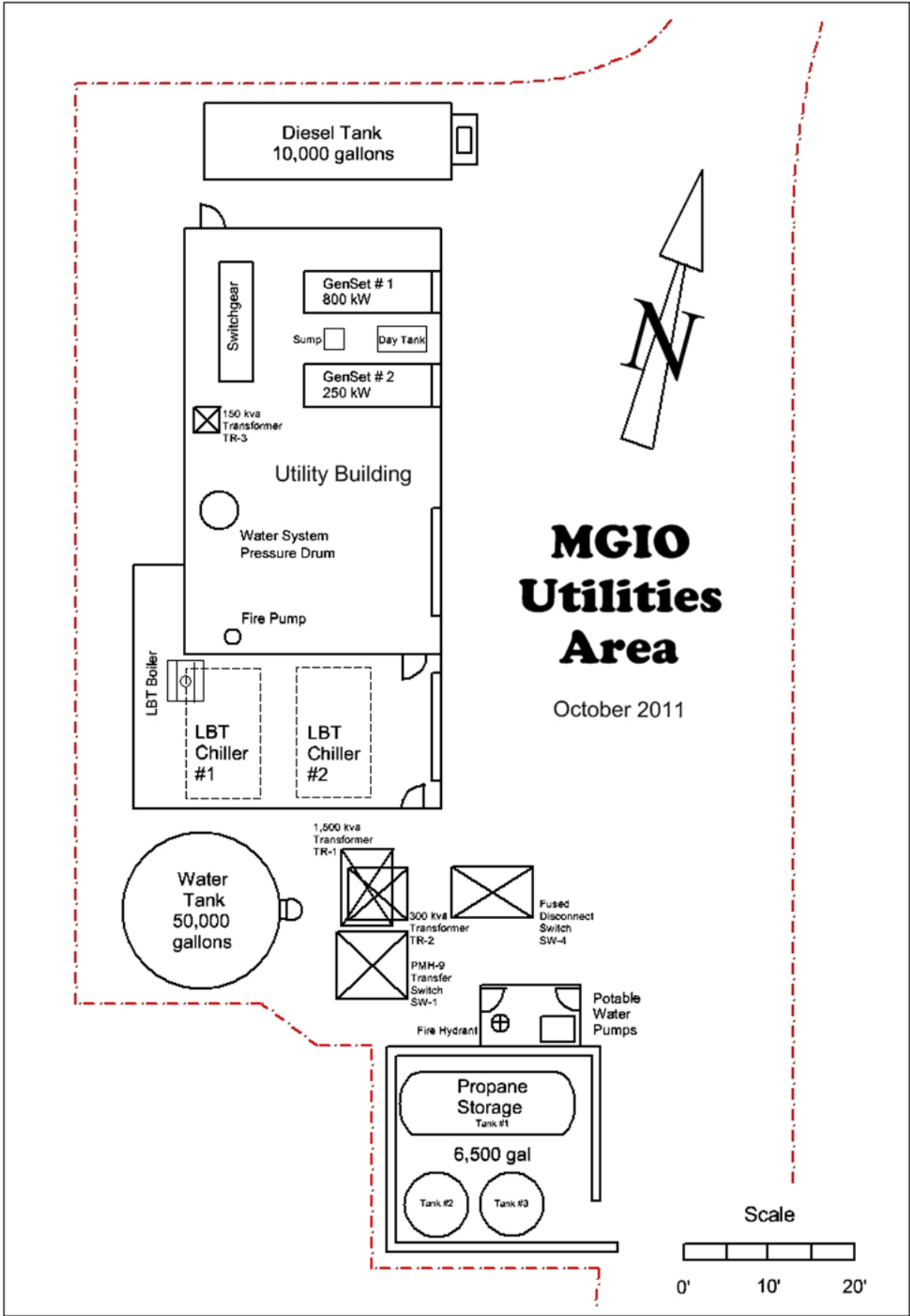

Exhibit 15: MGIO Utility Building, Water, and Propane Layouts



MGIO Utilities Area

October 2011

Exhibit 16: MGIO Power Distribution System

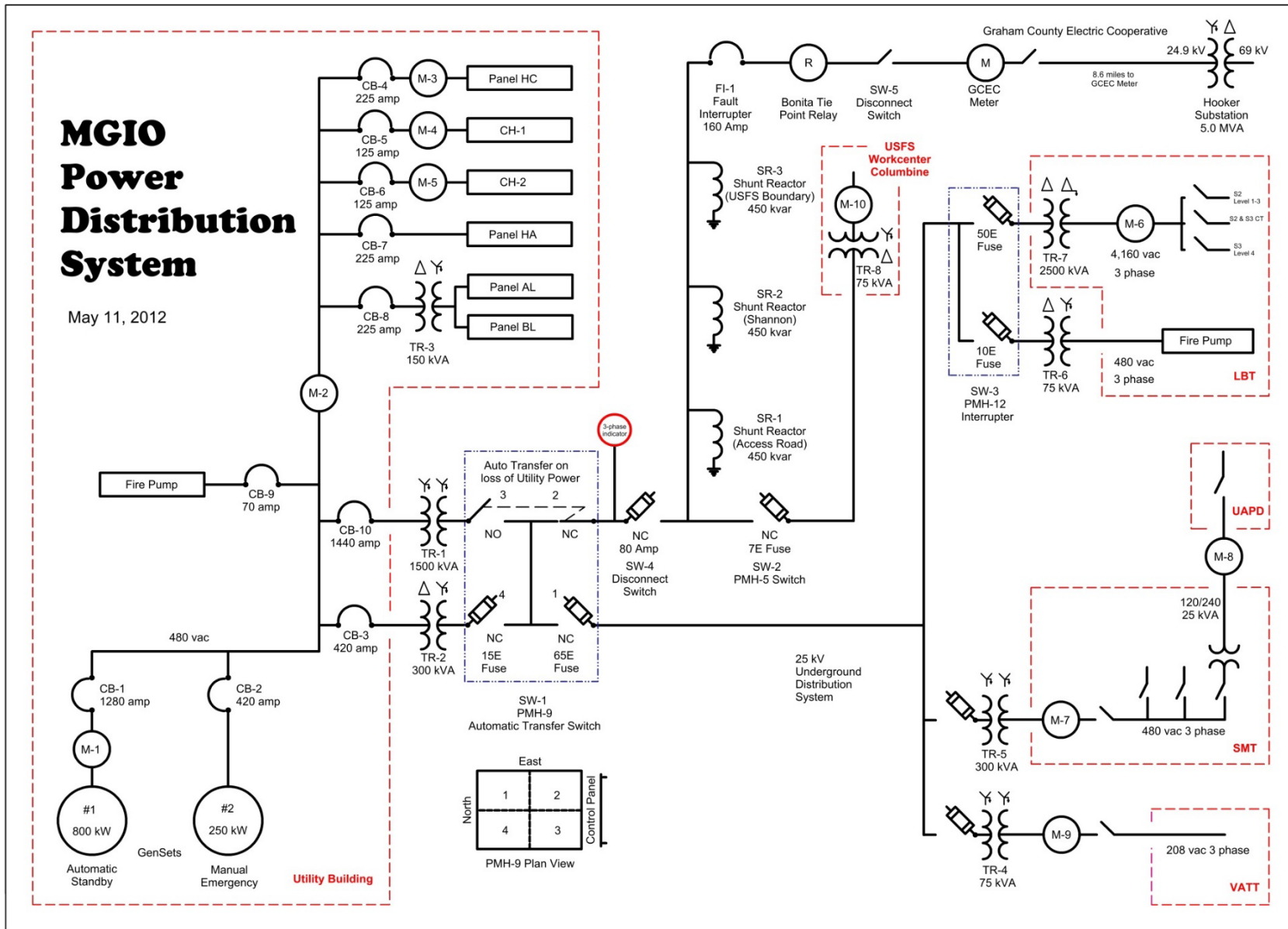
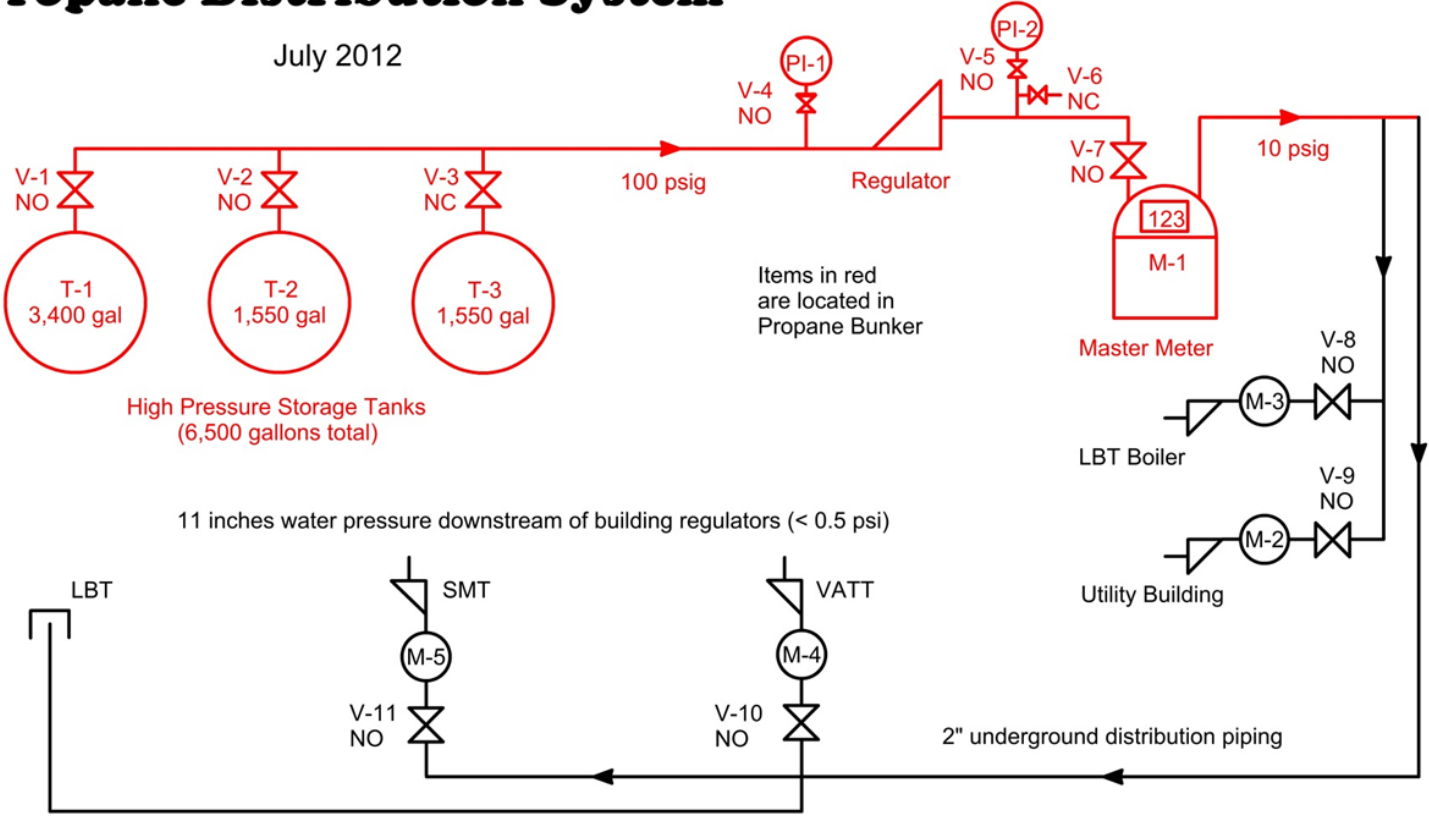

Exhibit 17: MGIO Propane Distribution System

MGIO Propane Distribution System

July 2012



Items in red are located in Propane Bunker

High Pressure Storage Tanks (6,500 gallons total)

11 inches water pressure downstream of building regulators (< 0.5 psi)

Master Meter

LBT Boiler

Utility Building

2" underground distribution piping

Exhibit 18: MGIO Water and Fire Protection Water Dist. Systems

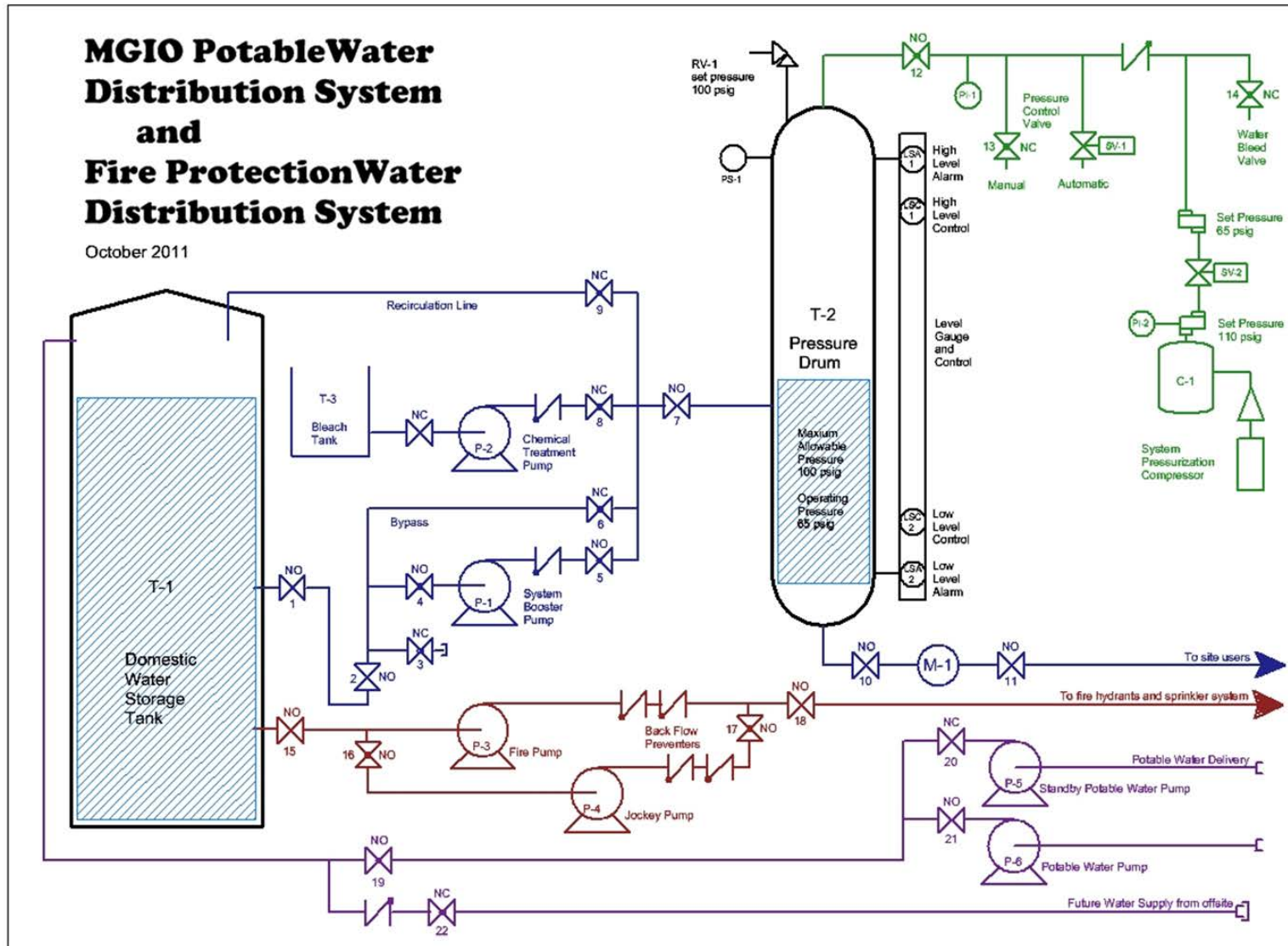

IC: INCIDENT COMMANDER
 USFS: US FOREST SERVICE
 ERT: EMERGENCY RESPONSE TEAM
 IAP: INCIDENT ACTION PLAN
 RMS: RISK MANAGEMENT SERVICES

Exhibit 19: MGIO Diesel Fuel Transfer System

MGIO Diesel Fuel Transfer System

July 2012

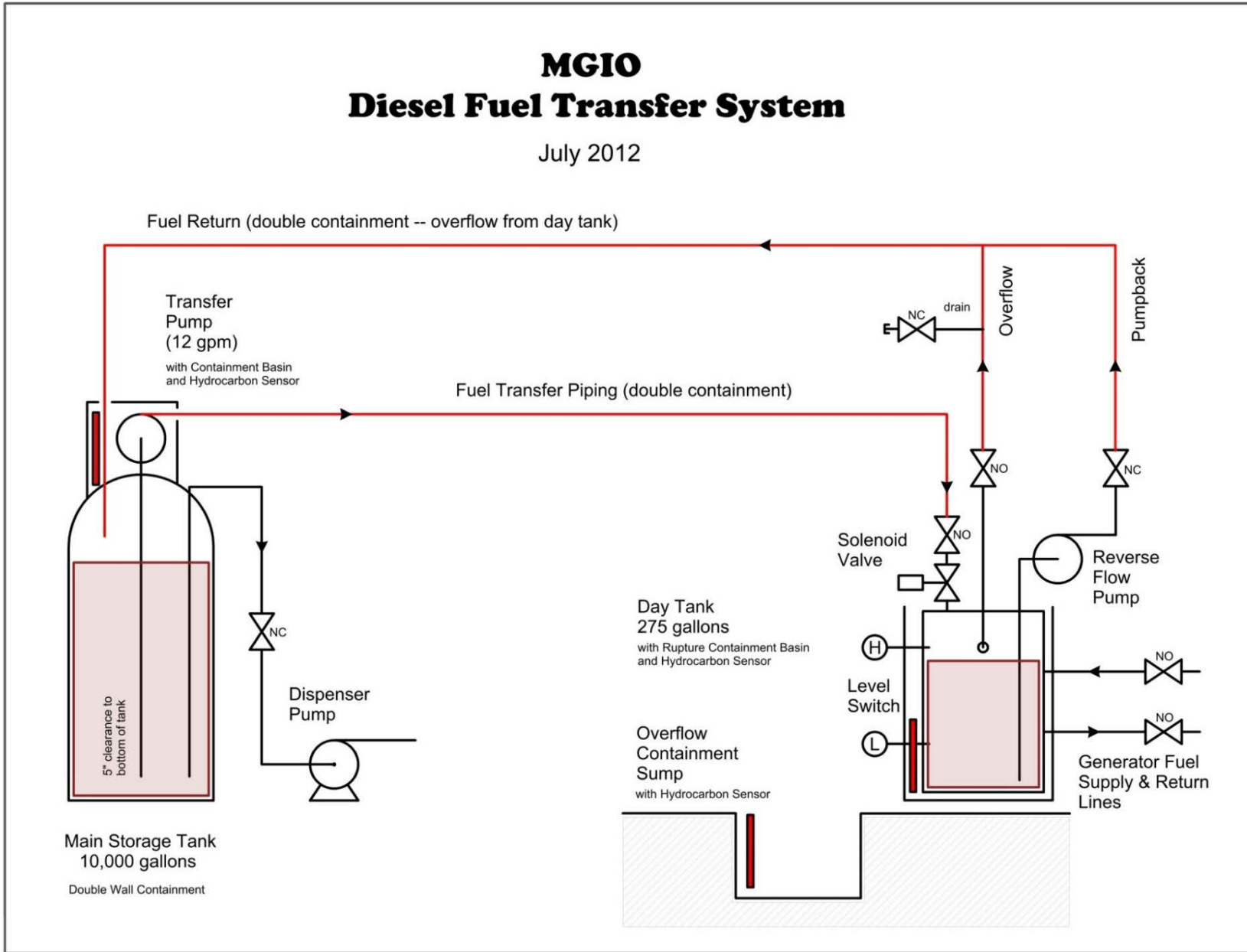

IC: INCIDENT COMMANDER
USFS: US FOREST SERVICE
ERT: EMERGENCY RESPONSE TEAM
IAP: INCIDENT ACTION PLAN
RMS: RISK MANAGEMENT SERVICES

Exhibit 20: Mt. Graham Regional Medical Center Location Map

IC: INCIDENT COMMANDER
USFS: US FOREST SERVICE
ERT: EMERGENCY RESPONSE TEAM
IAP: INCIDENT ACTION PLAN
RMS: RISK MANAGEMENT SERVICES

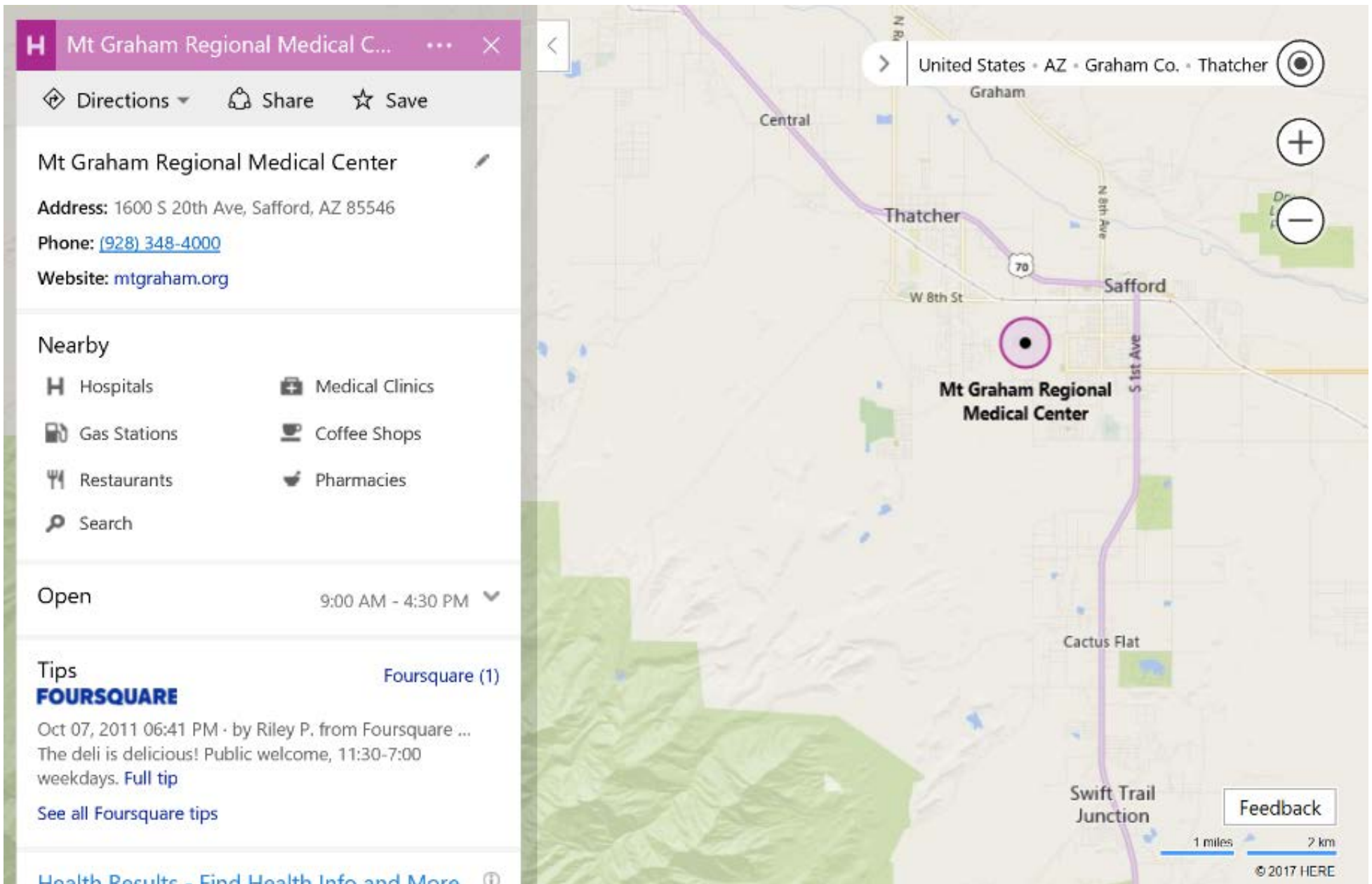
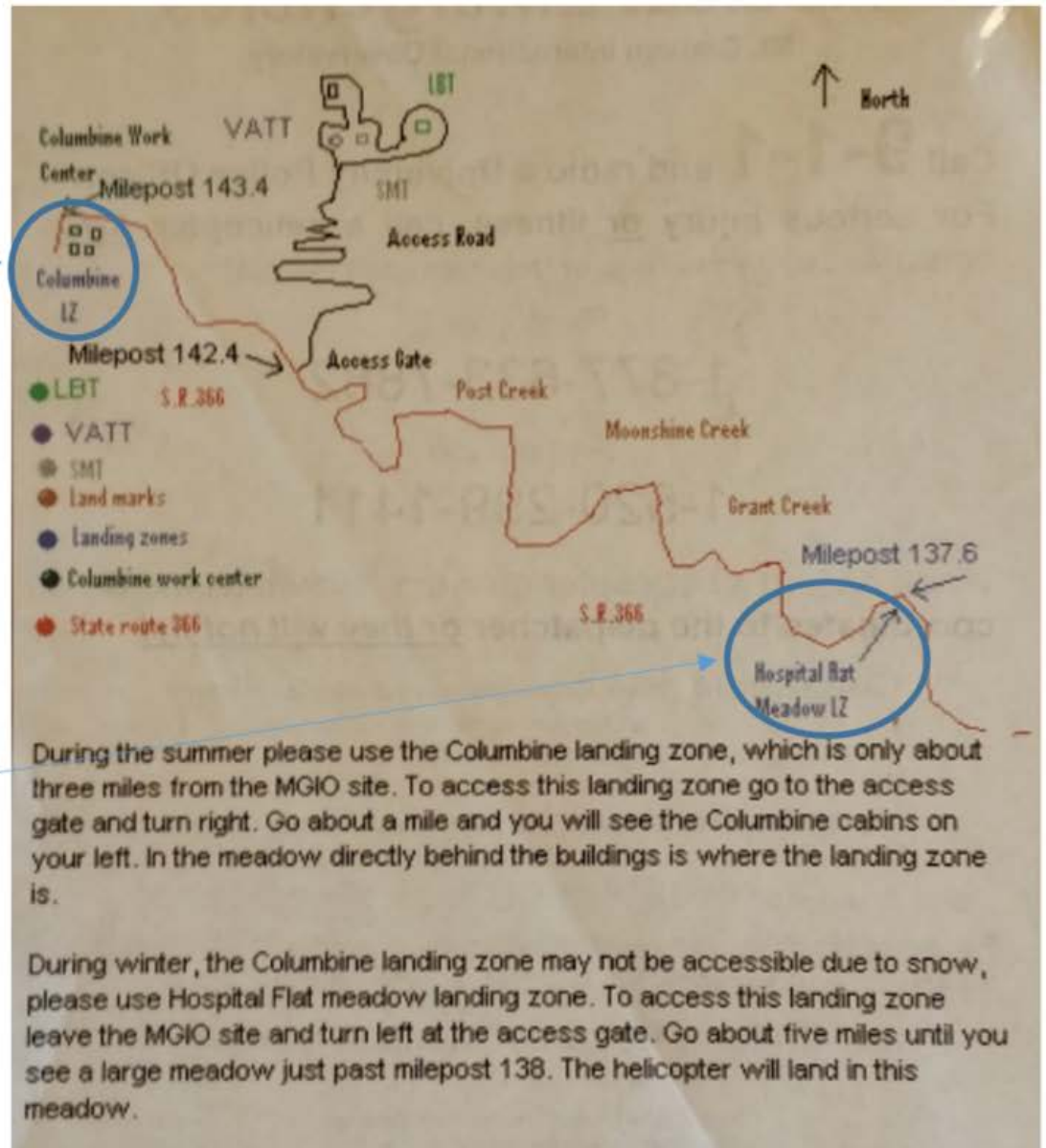

Exhibit 21: Helicopter Landing Map

1. Columbine is the first choice for helicopter landing site. (~15 mins away from LBT).

2. Hospital Flat is the second choice for helicopter landing site. (~30 mins away from LBT).



IC: INCIDENT COMMANDER
USFS: US FOREST SERVICE
ERT: EMERGENCY RESPONSE TEAM
IAP: INCIDENT ACTION PLAN
RMS: RISK MANAGEMENT SERVICES

Exhibit 22: Building Evacuation Assembly Area Map

Summit Building Evacuation Assembly Areas

Assembly locations are marked with a red “x” below.

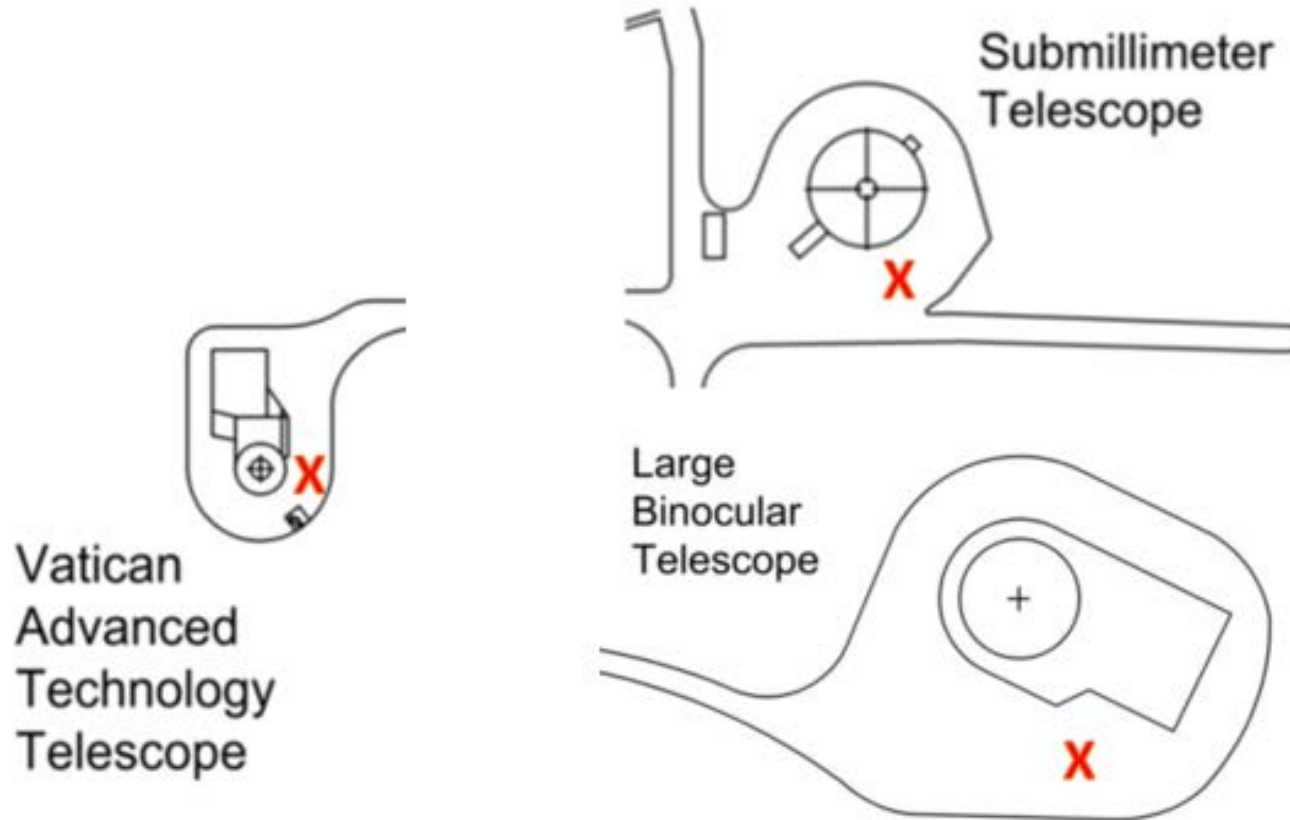

In Cold weather: meet in the foyer areas of the buildings, if it is safe to do so.

IC: INCIDENT COMMANDER
USFS: US FOREST SERVICE
ERT: EMERGENCY RESPONSE TEAM
IAP: INCIDENT ACTION PLAN
RMS: RISK MANAGEMENT SERVICES

General Summit Assembly Area (Marked with Red X):

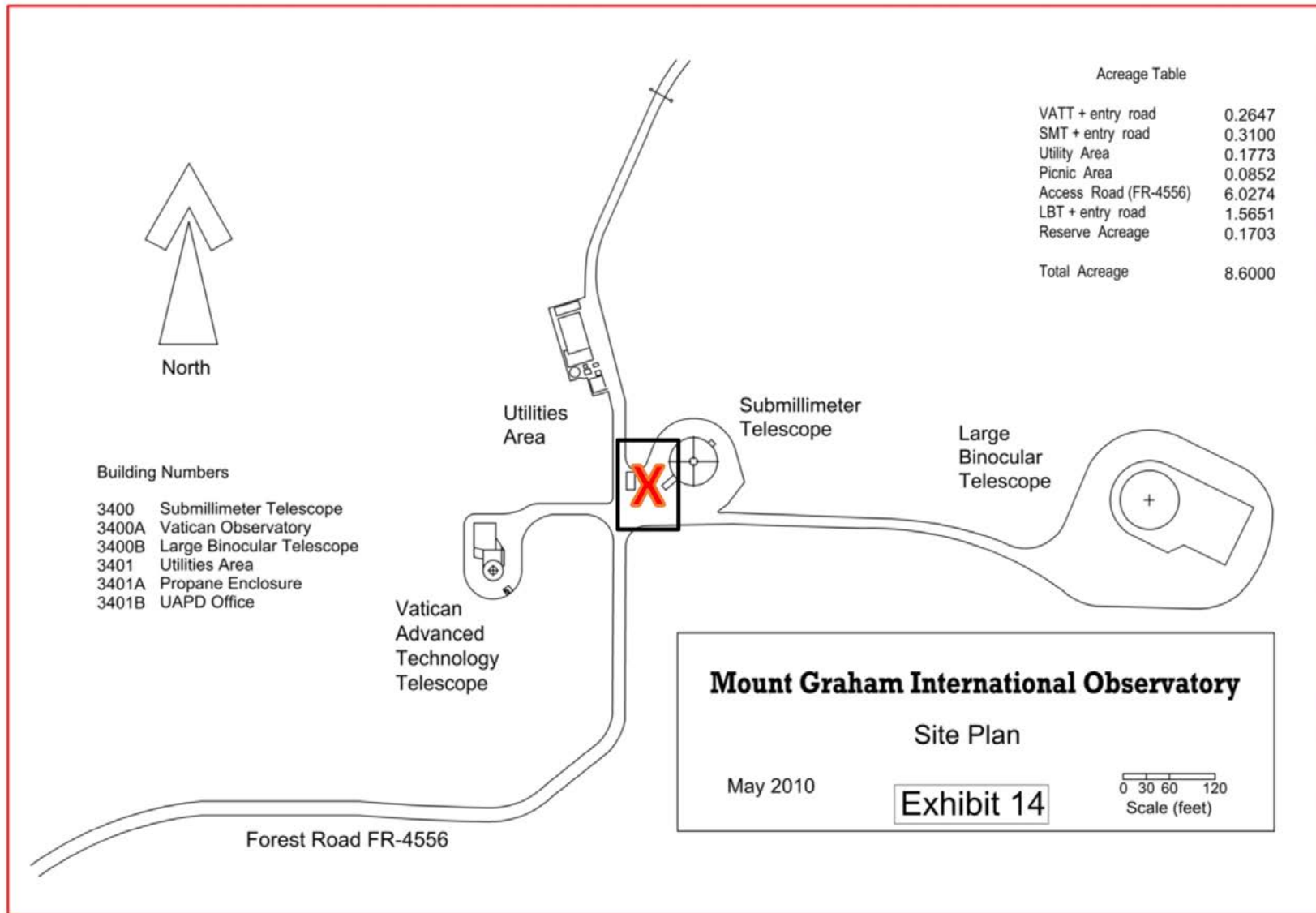

APPENDIX F: PERIODIC REVIEW, MAINTENANCE AND TESTING REQUIREMENTS

Item	What to Do	Frequency	Responsible Party
ERCP	Review and revise as necessary	Annual	Management
Emergency Contact Cards (at telephones)	Revise as necessary.	Annual and when changed	Each Building to manage their own contact cards.
SDSs for Chemicals	Revise as new chemicals AND SDS revisions come in.	Ongoing	Each building to manage their building list. MGIO to manage the MGIO list in Appendix J .
Drill/Formal Exercise of ERT	Test the senior staff, EOC, and at least one section of this ERCP.	Annual	Management
ERT Training	See Section 11.0 Training	Semi-Annual	MGIO
Backup Generators (800kW & 25kW)	Test, service, check fuel	Test = Monthly Service = 6 months Fuel Level Check: Pre-Winter and Pre-Fire	MGIO
Supplies for Shelter In Place	Ensure food/water supplies for 10 people for 7 days	Every 6 months	LBT
AED (Automatic External Defibrillator)	Inspect batteries and pads, report to UA	Annual	MGIO/UAPD/LBT
First Aid Kits	Inspect and Restock	Monthly, or as needed	Each Building to Manage, MGIO for UAPD Building and Evac Vehicles.
Fire Extinguishers	Inspect monthly and service annually	Monthly Annual	Each building to inspect monthly and arrange for annual service. MGIO for UAPD Building and Vehicles.
Eyewashes	Service, flush or replace, depending on the style	Monthly and per manufacturer's instruction	Each Building to Manage
Oxygen Tank	Inspect and recharge as needed	Monthly	Each building to manage. MGIO to

			manage emergency vehicle tanks.
Evacuation Vehicle	Inspect and maintain vehicle and components	Annual	MGIO
Building Fire Alarm Systems	System Test	Annual	UA Fire Safety (Joe Branaum)
Spill Response Gear	Inspect, restock, re-secure zip tie	Every 6 months and as needed	MGIO
Fire Fighter Gear	Inspect, restock	Every 6 months and as needed	MGIO
UPS Systems			Each building to manage.
LBTO Emergency Equipment	Various	Various	See M004s00310 section "Equipment" for full details.

APPENDIX G: ERT GUIDELINES

Emergency Response Team (ERT) Overview

The **Emergency Response Team (ERT)** is comprised of UA employees trained to respond to likely emergency situations at the observatory. ERT will respond to their level of training and ability (see [Section 11.0](#) for training requirements). Unless otherwise specified, ERT members are **not** EMTs or Paramedics. ERT will participate in training and drills, be “on call” while working on site, and be available to respond to emergencies should the legitimate need arise per the Contingency Plan. At times, this could mean ceasing day or nighttime operations in order to respond to a situation in another building.

Duty for Each Organization to Participate

The goal of Observatory Management is to maintain *a minimum* of 3 ERT members at the summit while the summit buildings are occupied. This should provide minimal but adequate coverage should an incident or injury occur, however additional trained ERT staff on site could help facilitate a more efficient and effective response to situations.

To best ensure the protection of life, environment and property at MGIO, **each UA group** on Mt. Graham (MGIO, LBTO, VATT, SMT, UAPD) has the duty to provide staff for the ERT role. While it is up to each group to determine who will be on ERT, it is *suggested* that as many staff as feasible attend, and that all staff assigned for sole or overnight duty at each telescope attend, at a minimum.

ERT Training & Drills

For training, see [Section 11.0](#).

Drills (table-top or live-action) should be performed during periodic training. Trainers should incorporate different elements of this ERCP into their design based on priorities, risks, and needs of the site and ERT.

The Multi-Building Approach

Because there could reasonably be one ERT member working at VATT, one at SMT, and the rest at the LBTO (all in different buildings), it is imperative that the teams be linked by communication means and that the individuals be prepared to respond should the need arise. ERT response could be local (within a building), or site-wide, depending on the situation. Primary communication will be via the MGIO radio system, as base station radios work on facility power, and hand-held units work should there be a power failure. Backup will be the microwave link telephone system and other means as described in [Appendix D](#). *Each group is responsible for monitoring the MGIO radio in their building(s) for emergency communications.*

Head Count/Roll Call (Who is on site)

In some emergency situations (and at any possible moment), it is imperative to know who is on site and in which buildings, particularly when performing area, building, or site evacuations. If someone

on site does not make it out safely, ERT members may need to re-enter to search for them, possibly putting themselves or others at risk.

MGIO tracks observatory-wide roll call in the MGIO base camp office:

- Brass Tag Board: MGIO Regular Staff (LBTO, SMT, VATT, UAPD, MGIO, UA Biologist employees)
- Visitor Log: All others (visitors, contractors, those without assigned brass)

LBTO, VATT, and SMT track roll call on boards in their lobbies/foyers. *All ERT should be familiar with roll call board locations in each building.*

Post-Incident Debriefing/Lessons Learned

A debriefing should follow immediately after all incidents (actual or false alarm). The goal of the debriefing is to gather facts and outline what went well and what could be improved in order to continually improve the emergency response system. This includes training, process/operations, communications, transportation, equipment and resources. ERT shall assign a scribe to take notes and send all comments to site management. Improvements shall be reviewed by management and incorporated into the ERCP as directed.

APPENDIX H: 911/EMS (EMERGENCY MEDICAL SYSTEM) CALLING GUIDELINES

IN AN EMERGENCY:

4. EVACUATE TO A SAFE LOCATION
 5. CALL FOR HELP
 - a. CALL “MAYDAY” 3 TIMES OVER RADIO FOR LOCAL RESPONDERS
 - Announce what happened and your location.
 - b. CALL 911 FROM A PHONE FOR OFFSITE PROFESSIONAL RESPONDERS
 - Physical Address of Observatory: 12500 W Swift Trail (State Rt. 366), Safford, AZ
 6. ASSIST AS NEEDED, BUT ONLY IF SAFE AND TO YOUR LEVEL OF TRAINING AND EXPERIENCE
- ➔ TURN TO “1.0 STARTING ALGORITHM” FOR SITUATIONAL GUIDE TO EMERGENCIES

NOTICE: The first person on the scene of an incident should assume incident command (see duties next page) until they may be relieved by appropriately trained person or necessity.

For serious injury or illness, ask dispatch for a helicopter and ambulance (in case one or the other can't make it). By calling 911, (GCSO dispatch) it could be requested, if needed, they contact UAPD dispatch, relieving that from the person dealing with the scene.

Further Guidance

Calling for help from MGIO

1. **MGIO Phone:** Dial 911 from an observatory telescope phone. You are at the MGIO on the summit of Mt. Graham. **Physical Address: 12500 W Swift Trail (State Rt. 366), Safford, AZ.**
 1. See [“What To Expect on the Call Below”](#)
2. **MGIO RPT radio channel:** Announce: "Attention MGIO, we have a (medical, fire, etc.) Emergency at the LBT. MGIO staff please advise."
3. *If NO MGIO phone and NO MGIO staff are available, dial Graham County Sheriff Dispatch from:*
 1. *LBT Satellite Phone +001-928-428-0808, or*
 2. *Cell phone: 928-428-0808*
4. **IF ALL ELSE FAILS:** Switch MGIO radio to channel: GCSO (Graham County Sheriff Office) and announce that there is a medical emergency. NE side of mountain: GCSO Ch. 1; SW side of mountain: GCSO Ch. 2 (Emergency only).

Note: All 911 calls made from the telescope (both 520 and 928 area code based numbers) are routed to the Graham County Sheriff's Office (GCSO) 24-hour dispatch in Safford. The GCSO will contact medical services, and the response provided will be based on the medical situation and weather. The response will either be by helicopter, ambulance, or both.

Speaking With Emergency Medical Services (EMS)

Inform the EMS dispatch operator of your location and the nature of the incident/injury. They should give instructions on tending to the patient (if they don't, then ask).

If someone is willing and able to transport the injured employee down in a vehicle to meet the emergency services, and it is safe to do so (weather ok, no neck injury), INFORM the EMS Dispatch:

1. We (MGIO) will transport the patient down to meet the helicopter or ambulance, and
2. Communication from inside the vehicle will be over the Satellite Phone. We will call GCSO Dispatch from the road. MGIO RPT (repeater) radio communication will be maintained with the observatory from the road, as well.
3. Give a description of the MGIO vehicle to the EMS dispatch operator so they know which vehicle to look out for.

If it is not safe to transport, inform the dispatch and keep dispatch on the phone until the ambulance arrives to the summit. Helicopter rescue will not be possible from the summit. (LBT needs to verify gate access)

Meeting Emergency Services off-Summit

Because of the remoteness of the MGIO site, it is standard protocol to transport patient(s) by vehicle from the summit down to meet the EMS dispatch. Use the **MGIO Emergency Vehicle** ([Appendix C](#)) to transport, or another vehicle can be used if necessary. *If it is not safe or possible to transport, notify EMS dispatch immediately that rescue must be made at the MGIO site.*

Helicopter:

Helicopters cannot land at the MGIO. The closest 2 locations they can land safely (in good weather) on the mountain are: Columbine (summer) or Hospital Flat (winter). See emergency helicopter map ([Appendix E](#)). If a helicopter is dispatched by EMS, MGIO must be able to transport the patient to the helipad specified by the EMS dispatcher. Always verify the meeting location (coordinates are included on the emergency contact lists) with the dispatch operator. Use the Satellite Phone to communicate with GCSO Dispatch on the road, and maintain radio communication with MGIO staff on MGIO RPT channel, as well.

Coordinates:

Columbine (Work Center) Primary during summer:

Latitude:	32 Degrees	42 Minutes	13 Seconds
Longitude:	-109 Degrees	54 Minutes	53 Seconds

Hospital Flat (Campground) Primary during winter:

Latitude:	32 Degrees	40 Minutes	05 Seconds
Longitude:	-109 Degrees	52 Minutes	39 Seconds

Note: Altitude density (i.e. low air density at high altitudes), at certain times of the year, can reduce efficiency and reliability of helicopter operations. Helicopter operation under certain circumstances may be curtailed.

Ambulance:

MGIO is 1.5 hours from Safford emergency ambulance services. Time is critical in a medical emergency, and so transporting a patient down in an MGIO vehicle to meet the ambulance can be the difference between life and death (could save up to 1 hour).

There is no pre-determined meeting location for ambulance rescue. Keep the EMS dispatch updated of patient status and vehicle location on the satellite phone, and maintain contact with MGIO via the MGIO RPT radio channel while traveling down the mountain. Flag the ambulance when passing on the road to safely transfer the patient.

What to Expect on the Call

When calling for emergency services, be prepared to answer the following questions:

1. Your name, organization, location, and phone number.
2. Description, number, location, and severity of injuries or medical problem.
3. Helicopter pickup site location (you may be asked for GPS coordinates):

-- Columbine – (primary site in summer – no snow)

LAT / LONG 32° 42' 13" -109° 54' 53"

-- Hospital Flat (primary site in winter – snow conditions)

LAT / LONG 32° 40' 05" -109° 52' 39"

4. Landing zone conditions - snowpack, condition, etc.
5. Weather conditions - wind, visibility, road conditions, etc.
6. Approximate height, weight, age, number of the patient(s) for flight purposes.
7. Are special tools required (i.e. Jaws of Life)?
8. Telephone number and name of contact person for call back if necessary.
9. Determine via the dispatcher the estimated time of arrival of the ambulance – write it down along with the time which the call was placed.

Immediate Caller Duties

1. Maintain radio/phone contact with air and ground ambulances.
2. Refer patient condition information (via UAPD) to ambulance en route.
3. Provide routing instructions -- landing site, pickup point etc.
4. Advise on specific staging location until safe for ambulance to enter area.
5. Maintain log on injured and their hospital destination.
6. Notify the appropriate contacts/authorities in [Appendix A](#).

APPENDIX I: STRUCTURE AND FOREST FIRE GUIDELINES

Building Fire Alarm Systems

Each building has its own fire alarm system with horns, strobes and panel, with the exception of the Utility building and UAPD Building. The VATT, SMT, and LBTO all report to UAPD Dispatch, which means if a fire alarm goes off, UAPD is immediately notified. Upon notification, UAPD will contact the on-duty officer (Wade Boltinghouse), MGIO, and GCSO until someone is reached.

	Alarm System	Report to UAPD	Suppression	Alarms Other Buildings?
LBTO	Horns/Strobes	Yes, microwave	Wet system (remains charged with water) Levels 1&2, Pre-Action system (charges with water when needed) Stairwells and elevator hoistways.	VIA MGIO Radio Only
VATT	Horns/Strobes	Yes, microwave		VIA MGIO Radio Only
SMT	Horns/Strobes	Yes, via microwave		VIA MGIO Radio Only
UAPD Building	Battery Operated with horn/strobe	No	Fire Extinguishers	No
Utility Building	None	NA	Fire Extinguishers	NA
Base Camp	None	NA	Fire Extinguishers	NA

MGIO Radio Fire Alarm Annunciation System

There is a “base station” MGIO Radio (currently on LBTO level 4 equipment room, by summer chiller) that is patched into the fire alarm system and transmits a pre-recorded audio message whenever a fire alarm is activated in either the LBTO, VATT, or SMT buildings. The pre-recorded message says “there is a fire alarm at the LBTO,” or VATT, or SMT, and it is sent over the MGIO Repeater Radio frequency. This unit is on a UPS.

Evacuation Due to Fire Alarm and False Alarms

If the fire alarm goes off in a building, all individuals are to immediately evacuate to the designated outside assembly area (See [Appendix E](#)). If the weather is inhospitable, individuals may assemble in

the foyer areas, if it is safe to do so. Additional ERT members may be called as needed via MGIO radio. [Section 4.4](#) covers this scenario.

Buildings at the summit experience false alarms a few times a year. False alarms can be caused by moths, dust, room humidifiers, faulty sensors, faulty pull stations, and other sources. It is always important to assume there is a real fire so not to be surprised by an actual fire. With that said, every opportunity to learn and improve the ERCP should be taken, and this includes false alarms. The ERT should debrief after every false alarm and discuss what went well and what could be improved. Ideas and comments should be sent to site management.

Fire Prevention and Suppression Guidelines

NOTE: All Exhibits referenced below can be found in [Appendix E](#).

Purpose: The intent of this plan is to outline channels of communication and responsibility for fire suppression and prevention activities, and to set up an aggressive attack procedure in the event a fire is discovered or reported in the vicinity of Emerald Peak. It is further intended that by advance preparation, physical damage and hazardous conditions may be reduced and an early recovery accomplished.

Scope: To eliminate all people caused fires within the MGIO area of responsibility as shown on the map (Exhibit 12&13 [Appendix E](#)). To take prompt, aggressive action on all fires that may occur.

Situation: The four major buildings (Utilities, VATT, SMT, and LBT) located on the Observatory grounds are constructed of primarily concrete and steel. One building, the UAPD Office, consists of a metal covered wood frame construction. Exhibits 11 through 13 present the location of the MGIO facilities in relation to the Pinaleño Mountains. Exhibit 14 presents a site plan of the Observatory facilities. Exhibit 15 shows the layout of the Utilities Area. Exhibits 16 through 18 outline utility schematic diagrams for electrical power, propane distribution and water distribution respectively.

The Observatory is located in a coniferous forest with significant amounts of fallen and decaying wood on the ground. The Observatory site is surrounded by an area designated as critical habitat for the Mt. Graham Red Squirrel, an endangered subspecies. Because of the elevation, the area is relatively cool and moist for most of the year. However, during certain portions of the year, particularly during a drought period, the fire danger could be classified very high to extreme (high rate of spread/high resistance to control). Because of the Observatory installation and because of the critical habitat designation, the area is classified as a high resource value area. The U.S. Forest Service will aggressively pursue fire suppression activities.

Common sense and constant vigilance must apply to all activities on the mountain and along the access road. Fire on the mountain could lead to large financial losses and possible loss of life. Because the Observatory could suffer major building fire damage, it is desirable that any response is immediate, containing any fire to as small an area as possible. The possibility exists that fire could spread as a result of exploding propane or fuel tanks. The fuel storage area is localized to the vicinity of the Utilities building. Exhibit 15 shows the fuel storage layout.

Standard Forest Service fire regulations are in effect at all times. Throughout the year, observers and visitors are cautioned against careless smoking and other actions that would contribute to a fire hazard. No open fires are permitted anywhere on the Observatory grounds.

Concept of Operations

If fire or explosion appear imminent, or either have occurred, all activity related to the operation of the Observatory will be stopped immediately. The Observatory shall immediately report all fires to the Forest Service. If appropriate, an Emergency Operations Center (EOC) may be established at the Base Camp ([Section 12.1](#)).

The Incident Commander (IC) will coordinate firefighting activities on-site. The IC will immediately assess the severity of the situation, and determine whether the fire is or is not readily controllable with existing portable fire extinguishers and/or on-site firefighting systems. Firefighting by the MGIO staff will not be done if personnel risk appears high. If the fire conditions could in any way endanger personnel in the buildings, the entire Observatory facility will be evacuated.

If the situation appears uncontrollable, and poses a direct threat to human life, a verbal warning will be given to all personnel fighting the fire to secure their emergency equipment and immediately prepare to evacuate the area. Time permitting, all utility services (propane and electricity) should be shut off at each building. Insure that all available water sprinkler and deluge systems (if installed in the future) remain in service.

For controllable situations, the Observatory relies on its own staff and equipment for small and accessible fires. The staff and equipment are prepared to react to structural (building) fires and take initial action on fires along the road or in the forest. Forest Service personnel are not trained in structural firefighting techniques and therefore will not assist in handling structural fires.

The Observatory relies on the Forest Service for all fire suppression activities in the forest surrounding the MGIO facility. Other agencies (such as the Sheriff's office, etc.) shall be called as required. The Observatory will assist with equipment and manpower to the extent that it protects its installations. After initial attack, communication and other efforts will be coordinated with the Forest Service. The Forest Service has the lead responsibility for all fires outside the Observatory building perimeters.

The IC will alert all University/MGIO personnel when it is safe to re-enter the buildings. The Forest Service Fire Management Officer will make the safety determination for fires outside MGIO building perimeters.

All equipment used in the emergency will be cleaned and repaired within 48 hours for use in the event of any future emergency. Sufficient backup equipment and supplies are available at the Base Camp to provide necessary coverage during this recovery period.

Task Assignments

- 1) Forest Service
 - a) Assume authority for direction of fire suppression forces (outside of MGIO building perimeter).
 - b) Direct mobilization of field forces as required.
 - c) Alert all departments and agencies involved to hazardous or potentially hazardous conditions.
 - d) Activate and check all emergency communications systems.
 - e) Provide public information data to the news media.
 - f) Recommend fire prevention measures to the MGIO Site Manager.
- 2) Observatory
 - a) Assume authority for direction of structural fire suppression activities.
 - b) Assist the Forest Service in fire suppression activities.
 - c) Ensure that all Observatory staff and visitors be informed of any fire and prepare for action or evacuation. It is possible that staff personnel could be sleeping in several buildings on the

mountain, unaware of advancing fire. All buildings must be checked for sleeping staff members.

- d) Assist the Forest Service in the location of water tanks or other facilities that may be required.
- 3) University of Arizona Police Department
- a) Establish and identify joint command post for the management of the law enforcement function.
 - b) In coordination with the Forest Service, control personnel and vehicle traffic to the area of the incident.
 - c) In coordination with the Forest Service, assist with field direction and control of all forces, except fire suppression. May assist the Forest Service in fire suppression activities.

UAPD MGIO FIRE ALARM NOTIFICATION CALL TREES

When a Star unit is on duty, notify them of the fire alarm immediately. The Star unit will give you further instructions or information on who to contact next.

If there are no Star units on duty and a fire alarm occurs:

- Contact the building that the alarm is coming from
 - **LBTO 626-1466, 626-3009, (928) 428-4286**
 - **SMTO 621-4328**
 - **VATT 626-6365**

- If no one is reached at the originating location of the fire alarm, try contacting someone at another building

- If you are unable to reach anyone at the observatory buildings, try contacting:
 - MGIO Base Camp 621-8650, (928) 428-2739 **Business Hours M-F, 0600-1630**
 - MGIO person “rotating on call” (928) 965-3100
 - Sgt. Wade Boltinghouse (928) 965-9325

- If you have not been able to reach any of the above, contact the following in order:
 - MGIO Director (Eric Buckley) (928) 965-3004 or MGIO Operations Superintendent Robert (Shane) Olsen (928) 965-3102
 - Graham County Sheriff’s Office (928) 428-0808 for a Deputy and or a fire department response.

Once contact has been made with a responsible party, they will determine if there is an active fire at a building and provide further instructions.

APPENDIX J: HAZARDOUS MATERIALS/SPILL RESPONSE GUIDELINES

Hazard Assessment & Determinations Guidelines

The Incident Commander (IC) and ERT staff shall use their best ability, training, and experience to determine if the incident is within the MGIO emergency response capabilities. If so, the IC will implement the necessary remedial action. If the incident is judged to be beyond the capabilities of the in-house response team, the IC will call in trained response teams on state contract that are especially equipped for hazardous material cleanup operations. Telephone numbers are listed in [Appendix A](#).

When assessing hazard and risk of an incident, it is important to consider both the direct and indirect effects of the release, fire, or explosion (e.g., the effects of any toxic, irritating, or asphyxiating gases that are generated or the effects of any hazardous surface water run-off from water or chemical agents used to control fire and heat-induced explosions), or of the medical situation, fire, weather, or loss of power or communications.

Evacuation and Notifications

If University personnel cannot control the incident without incurring undue risk, the IC will order the evacuation of all workers at risk, and notify the appropriate agencies of the situation (see [Appendix B](#)). The IC will immediately notify the appropriate local authorities. Specific criteria are listed in the SPCC Plan. If required, notify the National Response Center and the Arizona Department of Environmental Quality (ADEQ).

If the Emergency Coordinator determines that any persons outside of the MGIO facility are at risk as a result of incident, contact will be made with the appropriate persons to advise them of the risk and the need, or potential need, to institute off-site evacuation procedures. Local agencies and contacts for the Arizona Bible Camp and the Columbine Cabin Owners Association are listed in [Appendix A](#).

All personnel not involved with the incident response activity will be evacuated from the immediate area, and the area around the facility will be marked off with yellow hazard warning tape. Observatory personnel, UAPD, or in certain situations the Graham County Sheriff's Office, will be stationed around the evacuated area to prevent unauthorized personnel from entering the area.

Site Layout

See [Appendix E for maps](#).

Access Road: Arizona Highway 366 (Swift Trail) emanates from an intersection with Highway 191 and ascends the Pinaleno Mountains (landmark and milepost information are listed in Exhibit 9). The road surface is paved to milepost 136.2 - the High Peak Road (FR-507) intersection. Environmental exposure is greatest where Swift Trail crosses perennial streams. Names and locations of these crossings are: Noon Creek (milepost 121.0), Wet Canyon (milepost 123.6), Grant Creek (milepost 139.2), Moonshine Creek (milepost 140.6) and Post Creek (milepost 141.4).

Prevention Measures

Specific actions to prevent the recurrence or spread of fires, explosions or releases include stopping all operations, containing, collecting and released chemicals, and recovering or isolating containers. When ignitable materials are involved or in the area, all ignition sources will be removed, and care will be taken to avoid introducing ignition sources into the response activity (i.e. electrical pumps, flares, light switches, etc.). Additionally, surrounding materials that could be reactive with materials spilled or released will be removed from the area.

The MGIO maintains a variety of absorbent materials to contain and clean up chemical or fuel spills. These materials are stored at the Observatory site, on Observatory vehicles, and at the Base Camp. [Appendix C](#) lists locations and inventories of Emergency Response Equipment Lockers.

Chemicals on Site

The primary purpose of the Observatory facility is to provide a remote site in which to conduct astrophysical research. Operations and maintenance of the facility will require the use of small quantities of specific chemicals (identified in Exhibit 1) and the transport and handling of petroleum products such as propane, gasoline and diesel fuel (identified in Exhibit 2).

The chemicals will be used to clean electronic parts, printed circuit boards, etc. Also the majority of the acid/base chemicals will be used to clean and strip aluminum from telescope mirrors prior to re-aluminizing them. This process of on-site mirror aluminization generates wastewater with metals in solution. This wastewater is not classified as a hazardous waste. The chemical analysis of the wastewater is identified in Exhibit 1. In addition, disposal procedures are outlined for small quantities of waste oil from maintenance operations involving internal combustion engines.

SMT: The Submillimeter Telescope building has a small laboratory that contains small quantities (typically a gallon of each) of solvents such as methanol, ethanol, isopropyl alcohol, methyl-ethyl ketone, and trichloroethylene. The waste chemicals will be containerized appropriately after each use. Transportation and disposal of the chemical waste will be the responsibility of the RMS.

Compressed gas cylinders (oxygen/acetylene for welding; nitrogen and helium) are stored in the SMT building. Liquid Nitrogen (200 liter high-pressure Dewar) is maintained inside the building. A Dewar of Liquid Helium is also kept in the building.

VATT: No hazardous chemicals are kept in the Vatican Advanced Technology Telescope building. Small amounts of hydraulic oil (10 gallons) are stored in the basement. Compressed gas cylinders of carbon dioxide and nitrogen are stored in the observatory building. The gases are used to clean optical surfaces. Typically a Dewar of Liquid Nitrogen is kept in the dome to service instrumentation at the telescope.

LBT:

LBT Chemical Inventory

The LBT has a chemical inventory of chemicals on site located on the VCAN document control system: [M004s00710](#) Chemical Inventory for Observatory. Below is a summary of large quantities of hazardous chemicals on site.

Mirror Washing and Stripping

Operations of the Large Binocular Telescope entail the annual re-aluminization of the two eight meter diameter primary mirrors. Essentially the mirror will be cleaned and stripped of the old aluminum coating, placed in a vacuum chamber where a new thin film of aluminum will be deposited on the mirror's surface. The stripping process will require a mild acid solution to dissolve the aluminum followed by a basic rinse to neutralize the glass substrate. Large amounts of deionized water are used in the stripping process generating a rinsate volume of about 7,000 gallons. The waste stream is essentially water with a pH of about 7.4 (the volume of required chemicals and the analysis of the rinsate stream are included in Exhibit 1). The rinsate solution is collected in a sump where it is stored until pumped into a tanker truck and delivered to the Safford Municipal Sewage Treatment Plant.

The source chemicals for this process are located in the Mirror Washing/Aluminizing Storage room on level 4 in a blue corrosives cabinet:

- ~#3 2.5L bottles of Hydrochloric
- ~#3 2.5L bottles of Nitric Acid
- #1-2 Totes of Deionized water in High Bay

Compressed Gas and Liquid Nitrogen

Compressed gas cylinders are stored on the ground floor of the LBT building – up to four 119 gallon capacity trailer mounted pressurized Liquid Nitrogen supply tanks, four 220 cubic foot compressed Nitrogen gas tanks, two 220 cubic foot compressed Helium gas tanks, six 220 cubic foot bottles of liquid carbon dioxide and one 220 cubic foot compressed Argon gas tank.

Hydrostatic Bearing Oil

In addition to a 55 gallon drum of hydrostatic bearing oil (Mobile DTE-11), approximately 450 gallons of hydrostatic bearing oil is inventoried into the telescope's hydrostatic bearing system.

Ethylene Glycol

Level 4 also houses the ethylene glycol system used to balance the telescope.

Propane Cylinders

LBTO has propane cylinders in the following locations:

- Level 4 Mechanical Room on the eastern wall adjacent to the high-bay roof access door:
 - #3 42-lb cylinders and
 - #1 36-lb cylinder.
- Level 2 Balcony/Outside Storage Closet grill:
 - #1 20-lb cylinder

Propane Supply Line to LBTO

- LBTO has a propane supply line fed from the Propane Pad at the Utility Building by underground pipe that supplies a backup boiler in Level 1 Mechanical room 112.
- The pipe comes up on the southeast exterior wall of the fixed building enclosure.
- The supply line has a quarter-turn valve, which can be isolated outside the building as per below.



Gasoline for Vehicles

LBTO has a 3-gallon gasoline can stored in the flammable cabinet by the roll-up door of the high bay.

Other Flammable Liquids (small quantity containers)

The LBTO has a chemical inventory of various flammable storage cabinets located on the VCAN document control system: [M004s00710](#) Chemical Inventory for Observatory

Utilities: Lubricating oil (55-gallon tank) and diesel fuel (275-gallon day tank) are stored in the generator section of the Utilities Building. A 10,000 gallon above ground, double containment tank and a double containment transfer piping system is used as the main storage area and transfer system for diesel fuel.

The above ground diesel storage container meets all codes and Environmental Protection Agency specifications for above ground storage of petroleum products. For the purpose of equipment maintenance, 55 gallon drums of lubricating oil, hydraulic oil, ethylene glycol and a drum designated for waste oil will be kept in the utilities area.

A portable gas welding rig (oxygen/acetylene compressed gas cylinders) is used for maintenance on the Observatory grounds and stored in the Utilities Building.

In addition to the diesel generator room, the Utilities Building houses the potable water storage and distribution equipment. A fire pump designed for a pumping capacity of up to 1,000 gpm will maintain two fire hydrants in operation for a minimum of 15 minutes up to a maximum time of 50 minutes based on a full water storage tank.

All Buildings: All sewage will be contained in sealed vaults associated with the pertinent buildings. Pumps are used to transfer septic waste from the vaults to the truck. The septic waste is transported to the Safford Municipal Sewage Treatment Plant for disposal.

Safety Data Sheets (SDS; formally Material Safety Data Sheets)

Safety Data Sheets (SDSs) are provided by the chemical manufacturer and are required to be posted in all areas where the chemicals are used or stored. SDSs communicate health, safety, environmental, emergency, and regulatory information about the chemical. Each building will have its own SDS binder for the chemicals in the building. Because of the sheer number of SDSs (chemical products) used on site, MGIO has narrowed down the largest quantity and highest risk chemicals on site into the list below. SDSs for these chemicals will be on file in the Utility Building at the observatory site and at the Base Camp:

MGIO List of Top Chemicals on Site:

1. Nitrogen Gas/Liquid
2. Helium Gas/Liquid
3. Hydrochloric Acid
4. Isopropyl Alcohol
5. Methanol
6. Ethanol
7. Methyl-ethyl Ketone
8. Nitric Acid
9. Phosphoric Acid
10. Potassium Hydroxide
11. Trichloroethylene
12. Acetone
13. Cupric Sulfate
14. Calcium Carbonate
15. Ethylene Glycol
16. Carbon Dioxide Gas/Liquid
17. Acetylene Gas
18. Oxygen Gas

Furthermore, these data sheets are kept by all Emergency Coordinators; on-site, at the Utilities Building; at the Site Manager's Office located at the MGIO Base Camp, 1480 W. Swift Trail, Safford, AZ; and at the Risk Management Office at 220 W. Sixth Street, Tucson, AZ. Additional references concerning hazardous materials management are available at the Risk Management Office.

SDSs contain pertinent hazard information for the chemicals which may be stored at the site including (but not limited to):

- Identification of chemical components by name, including synonyms
- Identification of wastes' hazard characteristics (e.g., toxicity, corrosivity, reactivity, and ignitability);
- Important chemical and physical properties for which data are available, (e.g., vapor pressure, pH, and solubility in water);

- Fire control procedures (e.g., water or chemical foam);
- Appropriate procedures to counteract human exposure (e.g., thorough washing with soap and water in the event of dermal contact);
- Spill response and disposal procedures.

Additional information on specific chemicals can be obtained by calling the Chemical Transportation Emergency Center (CHEMTREC) at their 24 hour phone number 1-800-424-9300 extension #1 (emergency hotline). They will provide immediate advice for those personnel at the scene of a chemical spill. CHEMTREC will also provide contact with the shipper/manufacturer of the chemicals involved in the incident.

Other than fuel, spills that may occur will typically be no larger than five gallons. There will be occasions however, in which MGIO staff will handle containers of up to 55 gallons. Small container sizes and small transport volumes reduce the exposure to significant spill situations. The extent of any spill will be easily approximated because of the containers involved.

Reportable Quantity Requirements for Chemical Spills

<u>CAS #</u>	<u>Description</u>	<u>Concentration</u>	<u>Volume/ Weight (lbs)</u>	Annual	Reportable
				<u>Transportation Occurrence</u>	<u>Quantity¹ (lbs.)</u>
7727-37-9	Nitrogen Gas/Liquid	100%	gas cylinder/40	52	None
7440-59-7	Helium Gas/Liquid	100%	gas cylinder/40	52	None
124-38-9	Carbon Dioxide Gas	100%	gas cylinder/40	3	None
7782-44-7	Oxygen Gas	100%	gas cylinder/40	8	None
74-86-2	Acetylene Gas	100%	gas cylinder/40	8	None
7647-01-0	Hydrochloric Acid	37%	50 liters/132	1	5,000
67-63-0	Isopropyl Alcohol	--	16 liters/28	1	None
67-56-1	Methanol	--	8 liters/14	1	5,000
64-17-5	Ethanol	--	8 liters/16	1	None
78-93-3	Methyl-ethyl Ketone	--	8 liters/16	1	5,000
7697-37-2	Nitric Acid	70%	100 liters/311	1	1,000
7664-38-2	Phosphoric Acid	85%	17.5 liters/65	1	5,000
1310-58-3	Potassium Hydroxide	pellet	7 kilograms/16	1	1,000
79-01-6	Trichloroethylene	--	8 liters/32	1	1,000
67-64-1	Acetone	95-99%	16 liters/28	1	5,000
107-21-1	Ethylene Glycol Antifreeze	--	55 gallons/495	2	None
7758-98-7	Cupric Sulfate	(anhydrous-power)	6 kilograms/14	1	10
471-34-1	Calcium Carbonate	(anhydrous-power)	10 kilograms/22	1	None
None	Mirror Rinse Solution ²	--	~7,000 gallons	1	None

Notes:

1. Reportable Quantities referenced in Appendix to 49 CFR 172.01, Table 1 - List of Hazardous Substance and Reportable Quantities.
2. Chemical Analysis Attached - this wastewater stream is not classified as hazardous waste as defined in 40 CFR 261.30, Subpart D.



Date: August 6, 1987

MEMORANDUM
University of Arizona

To: John Ratje, Assistant Director
Steward Observatory

Dept: Risk Management

From: Lloyd M. Wundrock *L. M. Wundrock*
Chemical Waste Program Coordinator

Campus Ext: 1-5861

Subject: Mirror Cleaning Solution

Due to the fact that your cleaning is a batch type operation and that the analysis represents a concentrated solution prior to water rinsing in the amount of 15 times, I conclude the following:

1. The waste component concentrations are less than those of federal guidelines defining hazardous waste.
2. Because of the volume of water used in the rinsing operation, the waste is also below Pima County discharge limits.

Therefore, wastewater generated by the cleaning process can be introduced into the sewer or allowed to flow onto the ground.

If you have any questions or concerns, please contact me.

LMW:kf

cc: Steve Holland
Martha A. Anderson

Sample Analysis	micrograms / milliliter		sample submitted on 10/16/1986
	Sample #1	Sample #2	
Cr	<0.2	<0.2	
Cd	0.09	0.09	
Ba	0.60	0.40	
Cu	8.0	6.5	
Pb	0.56	0.50	Lead is higher than expected (Sunnyside water has high lead content).
Ag	<0.1	<0.1	
pH	7.88	8.27	

Fuel and Lubricant Transport, Consumption and Storage Requirements

<u>Description</u>	Transport	Annual Transportation	Annual Consumption	On-Site Storage
	<u>Volume</u>	<u>Occurrence</u>	<u>Consumption</u>	<u>Capacity</u>
Gasoline	5 gallons	6	30 gallons	20 gallons
Diesel (#1)	3,500 gallons	3	10,500 gallons	10,000 gallons
Propane	2,000 gallons	12	30,000 gallons	6,500 gallons
Lubricating Oil	55 gallon drum	3	165 gallons	55 gallons
Waste Oil	55 gallon drum	3	165 gallons	55 gallons
Kerosene	55 gallon drum	1	55 gallons	55 gallons
Hydraulic Oil	55 gallon drum	3	165 gallons	55 gallons

Notes:

1. The above fuels and lubricants are not listed for "Reportable Quantities" as referenced in Appendix to 39 CFR 172.01, Table 1 - List of Hazardous Substances and Reportable Quantities. If a spill involves "waters of the U.S.", a reportable oil spill is any quantity that can cause a film or sheen on water (40 CFR 110).

Liquid Nitrogen Transport DOT/CDL Exemptions



Department of Risk Management & Safety
Division of Business Affairs

University Services Annex
Building 300A
220 W. Sixth St., 4th Floor South
P.O. Box 210300
Tucson, AZ 85721-0300
(520) 621-1790
Fax: (520) 621-3706
<http://risk.arizona.edu/>

DATE: June 2008
TO: To Whom It May Concern
SUBJECT: University of Arizona Personnel Transporting Hazardous Materials

The Department of Transportation Pipeline and Hazardous Materials Safety Administration has determined that a state agency, such as the University of Arizona, transporting hazardous materials for its own use, by its own personnel and in its own vehicles is not engaged in transportation in commerce and is not subject to the Hazardous Materials Regulations. This interpretation is based upon 49 CFR 171.1(c)(5). Therefore, the University of Arizona does not need to placard vehicles transporting hazardous materials, mark or label packages, or provide shipping papers for shipments. In addition, university personnel performing these transportation tasks are not required to have a Commercial Driver's License

In the event of an accidental release, the University will provide paperwork identifying the hazardous materials being shipped to aide emergency responders. The University will also ensure that the hazardous material is properly packaged to reduce the potential of release. Questions regarding this interpretation of DOT regulations may be directed to the University of Arizona, Department of Risk Management and Safety.

A handwritten signature in black ink, appearing to read 'Steven C. Holland'.

Steven C. Holland, CRM ARM
Director of Risk Management and Safety





Department of Risk Management & Safety
Division of Business Affairs

University Services Annex
Building 300A
220 W. Sixth St., 4th Floor South
P.O. Box 210300
Tucson, AZ 85721-0300
(520) 621-1790
Fax: (520) 621-3706
<http://risk.arizona.edu/>

FAX TRANSMITTAL COVER SHEET

DATE: 5/6/08
TO: Name: Bob Kingsley
Company/Department: Insurance Dept
FAX Number: 621-6337
FROM: Name: DET Phone: 621-5701
University of Arizona
Department of Risk Management and Safety
Environmental Compliance Team
(520) 621-1790 FAX: (520) 626-4925
e-mail: hazmat@email.arizona.edu

NUMBER OF PAGES TRANSMITTED, INCLUDING THIS COVER PAGE: 9

ORIGINAL DOCUMENT WILL WILL NOT FOLLOW.

COMMENTS/INSTRUCTIONS:
DET interpretation of "In Commerce".



Careers | Contact Us | FAQs | Site Map

Advanced Search

For the Public

Hazmat Safety
Community

Pipeline Safety
Community

Media | Congress

Doing Business with
PHMSA

- About Us
- Calendar
- Contact Us
- Data & Statistics
- Electronic Services
- Enforcement
- FAQs
- Glossary
- Grants & State Programs
- Hazardous Materials Information Center
- Incident Reporting
- International Standards
- Interpretations
- Library
- NTSB Safety Recommendations
- Preemption Index
- Registration
- Risk Management
- Rules & Regulations
- Security
- Special Permits & Approvals
- Training & Outreach

[Home](#) » [Hazmat Safety Community](#) » [Interpretations](#)

PHMSA Interpretation #07-0043

Mar 26, 2007

PHMSA Response Letter

Mar 26, 2007

Mr. Gary M. Spichiger
 Radiation Safety Officer
 Department of Environmental Health and Safety
 Western Kentucky University
 1906 College Heights Boulevard, #11046
 Bowling Green, KY 42101-1046

Reference No. 07-0043

Dear Mr. Spichiger:

This is in response to your February 15, 2007 letter requesting clarification on how the Hazardous Materials Regulations (HMR; 49 CFR Parts 171-180) apply to the transport of radioactive materials by a university that is a state agency. Specifically, you state your university employees transport packaged instruments and articles containing excepted quantities of Class 7 (radioactive) material appropriately labeled "RADIOACTIVE WHITE-1" OR "RADIOACTIVE YELLOW-IT" in university-owned vehicles, and ask if the employees are required to receive the hazardous material training for drives prescribed in § 177.816.

The answer is no. A state agency, such as a state university, that transports hazardous materials for its own use, using its own personnel and vehicles is not engaged in transportation in commerce and, therefore, is not subject to the HMR. However, if the university transports hazardous materials using a commercial carrier, such as a contractor or a contract or common carrier, it is subject to the requirements of the HMR, including those prescribed in § 177.816. See § 171.1(Introductory paragraph) and (c).

I hope this satisfies your request.

Sincerely,

Hattie L. Mitchell, Chief
 Regulatory Review and Reinvention
 Office of Hazardous Materials Standards

177.816

PDF Version

Regulation References:

49 CFR 177.816

More Interpretations on this topic

[Read the Regulation](#)

Home



- Mission and Goals
- About the Agency
- Key Officials
- Organization
- Calendar

Promoting Safety & Security

- Regulations
- Special Permits & Approvals
- International Standards
- Security
- Initiatives



Careers | Contact Us | FAQs | Site Map

Advanced Search

For the Public

Hazmat Safety Community

Pipeline Safety Community

Media | Congress

Doing Business with PHMSA

- [About Us](#)
- [Calendar](#)
- [Contact Us](#)
- [Data & Statistics](#)
- [Electronic Services](#)
- [Enforcement](#)
- [FAQs](#)
- [Glossary](#)
- [Grants & State Programs](#)
- [Hazardous Materials Information Center](#)
- [Incident Reporting](#)
- [International Standards](#)
- [Interpretations](#)
- [Library](#)
- [NTSB Safety Recommendations](#)
- [Preemption Index](#)
- [Registration](#)
- [Risk Management](#)
- [Rules & Regulations](#)
- [Security](#)
- [Special Permits & Approvals](#)
- [Training & Outreach](#)

[Home](#) » [Hazmat Safety Community](#) » [Interpretations](#) » [Interpretations by Regulation](#)

PHMSA Interpretation #04-0256

Nov 19, 2004

PHMSA Response Letter

Nov 19, 2004

Mr. David Wilk Reference No. 04-0256
Director, Radiation Safety Department
University of South Alabama
257 CSAB
Mobile, AL 36688-0002

Dear Mr. Wilk:

This responds to your letter requesting clarification on the applicability of the Hazardous Materials Regulations (HMR; 49 CFR Parts 171-180) to state agencies who offer for transportation or transport hazardous materials.

Your understanding of the HMR is correct. Hazardous materials transported for noncommercial purposes by a state agency, including state-chartered and funded universities, are not subject to the HMR. Thus, transportation of a hazardous material in state-owned or state-leased vehicles operated by state employees is not subject to the HMR. However, transportation conducted by a private entity under contract to a state agency is subject to all applicable HMR requirements. Similarly, hazardous materials offered for transportation by a state agency to a commercial carrier are subject to all applicable HMR requirements.

I trust this satisfies your inquiry.

Sincerely,

Hattie L. Mitchell
Chief, Regulatory Review and Reinvention
Office of Hazardous Materials

171.1

PDF Version

Regulation References:

49 CFR 171.1

[More Interpretations on this topic](#)

[Read the Regulation](#)

Home



- [Mission and Goals](#)
- [About the Agency](#)
- [Key Officials](#)
- [Organization](#)
- [Calendar](#)

Promoting Safety & Security

- [Regulations](#)
- [Special Permits & Approvals](#)
- [International Standards](#)
- [Security](#)
- [Initiatives](#)



Careers | Contact Us | FAQs | Site Map

Advanced Search

For the Public

Hazmat Safety
Community

Pipeline Safety
Community

Media | Congress

Doing Business with
PHMSA

- [About Us](#)
- [Calendar](#)
- [Contact Us](#)
- [Data & Statistics](#)
- [Electronic Services](#)
- [Enforcement](#)
- [FAQs](#)
- [Glossary](#)
- [Grants & State Programs](#)
- [Hazardous Materials Information Center](#)
- [Incident Reporting](#)
- [International Standards](#)
- [Interpretations](#)
- [Library](#)
- [NTSB Safety Recommendations](#)
- [Preemption Index](#)
- [Registration](#)
- [Risk Management](#)
- [Rules & Regulations](#)
- [Security](#)
- [Special Permits & Approvals](#)
- [Training & Outreach](#)

[Home](#) » [Hazmat Safety Community](#) » [Interpretations](#) » [Interpretations by Regulation](#)

PHMSA Interpretation #03-0326

Feb 13, 2004

PDF Version

PHMSA Response Letter

Feb 13, 2004

Regulation References:

49 CFR 171.1

[More Interpretations on this topic](#)

[Read the Regulation](#)

Home



- [Mission and Goals](#)
- [About the Agency](#)
- [Key Officials](#)
- [Organization](#)
- [Calendar](#)

Promoting Safety & Security

- [Regulations](#)
- [Special Permits & Approvals](#)
- [International Standards](#)
- [Security](#)
- [Initiatives](#)

Mr. Mitch Ricketts, CSP Reference No. 03-0326
 Health, Safety & Environment Quality Coordinator
 Kansas State University
 113 Waters Hall
 Manhattan, KS 66506

Dear Mr. Ricketts:

This responds to your December 10, 2003 letter requesting clarification of the Hazardous Materials Regulations (HMR; 49 CFR Parts 171-180) applicable to the transportation of hazardous materials by state agencies. Specifically, you ask to what extent state agencies are subject to regulation under the HMR.

As provided in your letter, Kansas State University is a state agency operating research farms throughout the state of Kansas. Portions of your crops are sold, while others are used for research purposes only. You question whether the transport of hazardous materials by the University from the point of purchase to farms throughout the state is regulated by the HMR. In addition, you ask whether the transport of pesticides and other chemicals from your farms throughout the state to your central hazardous waste storage site in Manhattan, Kansas, is regulated by the HMR.

As specified in § 171.1, the HMR govern the safe transportation of hazardous materials in commerce. A state agency or local jurisdiction that transports hazardous materials for governmental purposes using its own personnel is not engaged in transportation in commerce, and, therefore, is not subject to the HMR. However, if the state agency or local jurisdiction transports hazardous materials for a commercial purpose or offers hazardous materials, including hazardous waste, for transportation to a commercial carrier, then the HMR apply. Although some of the crops raised on Kansas State University farms are sold, the underlying purpose of the farming operations is to support the education and research mission of the University. Therefore, the transportation of hazardous materials by the University from the point of purchase to farms throughout the state and of hazardous waste from the farm to your central storage site is not subject to the HMR when the transportation is performed by University personnel.

I hope this information is helpful.

Sincerely,

Edward T. Mazzullo
 Director, Office of Hazardous
 Materials Standards

171.1



Careers | Contact Us | FAQs | Site Map

Advanced Search

For the Public

Hazmat Safety Community

Pipeline Safety Community

Media | Congress

Doing Business with PHMSA

- About Us
- Calendar
- Contact Us
- Data & Statistics
- Electronic Services
- Enforcement
- FAQs
- Glossary
- Grants & State Programs
- Hazardous Materials Information Center
- Incident Reporting
- International Standards
- Interpretations
- Library
- NTSB Safety Recommendations
- Preemption Index
- Registration
- Risk Management
- Rules & Regulations
- Security
- Special Permits & Approvals
- Training & Outreach

Home

About PHMSA



- Mission and Goals
- About the Agency
- Key Officials
- Organization
- Calendar

Promoting Safety & Security

- Regulations
- Special Permits & Approvals
- International Standards
- Security
- Initiatives

[Home](#) » [Hazmat Safety Community](#) » [Interpretations](#)

PHMSA Interpretation #99-0103

Apr 27, 1999

PHMSA Response Letter

APR 27, 1999

Mr. Thomas S. Smith
 Truckmaster
 Department of the Army
 182nd Transportation Company (MTP)
 901 Airport Access Road
 Traverse City, MI 49686

Ref. No. 99-0103

Dear Mr. Smith:

This is in response to your letter dated April 15, 1999, regarding the applicability of the Hazardous Materials Regulations (HMR; 49 CFR Parts 171-180) to government agencies transporting hazardous materials.

The statutory authority granted to the Department of Transportation under the Federal hazardous materials transportation law (49 U.S.C. 5101 et seq.) is limited to transportation of hazardous materials in commerce. Shipments of hazardous materials transported by a government entity in vehicles operated by government personnel for noncommercial purposes are not subject to the HMR. However, if the purpose is commercial or if the government entity offers hazardous material for transportation to commercial carriers, then the HMR apply.

I hope this satisfies your request.

Sincerely,

John A. Gale
 Transportation Regulations Specialist
 Office of Hazardous Materials Standards

171.1

PDF Version

Regulation References:
49 CFR 171.1

More Interpretations on this topic
Read the Regulation



[Careers](#) | [Contact Us](#) | [FAQs](#) | [Site Map](#)

[Advanced Search](#)

[For the Public](#)

[Hazmat Safety Community](#)

[Pipeline Safety Community](#)

[Media | Congress](#)

[Doing Business with PHMSA](#)

- [About Us](#)
- [Calendar](#)
- [Contact Us](#)
- [Data & Statistics](#)
- [Electronic Services](#)
- [Enforcement](#)
- [FAQs](#)
- [Glossary](#)
- [Grants & State Programs](#)
- [Hazardous Materials Information Center](#)
- [Incident Reporting](#)
- [International Standards](#)
- [Interpretations](#)
- [Library](#)
- [NTSB Safety Recommendations](#)
- [Preemption Index](#)
- [Registration](#)
- [Risk Management](#)
- [Rules & Regulations](#)
- [Security](#)
- [Special Permits & Approvals](#)
- [Training & Outreach](#)

[Home](#) » [Hazmat Safety Community](#) » [Interpretations](#)

PHMSA Interpretation #98-0380

Jan 13, 1999

PHMSA Response Letter

JAN 13, 1999

Mr. Richard Bingham
City of Tulsa
707 So. Houston, Room 202
Tulsa, OK 74127

Ref. No. 98-0380

Dear Mr. Bingham:

This is in response to your letter of December 18, 1998, requesting clarification of whether government vehicles transporting hazardous materials are subject to the Hazardous Materials Regulations (HMR; 49 CFR Parts 171-180).

Shipments of hazardous materials transported by a government entity in vehicles operated by government personnel for noncommercial purposes are not subject to the HMR (including placarding). However, if the purpose is commercial or if the government entity offers hazardous material for transportation to commercial carriers, then the HMR apply.

I hope this satisfies your request.

Sincerely,

John A. Gale
Transportation Regulations Specialist
Office of Hazardous Materials Standards

171.1

[Home](#)

[About](#)

[PHMSA](#)

- [Mission and Goals](#)
- [About the Agency](#)
- [Key Officials](#)
- [Organization](#)
- [Calendar](#)

[Promoting Safety & Security](#)

- [Regulations](#)
- [Special Permits & Approvals](#)
- [International Standards](#)
- [Security](#)
- [Initiatives](#)

PDF Version

Regulation References:
49 CFR 171.1

[More Interpretations on this topic](#)
[Read the Regulation](#)



U.S. Department
of Transportation
**Research and
Special Programs
Administration**

Office of the
Chief Counsel

400 Seventh Street, S.W.
Washington, D.C. 20590

(202) 366-4400
Room 8407

Mr. Dave W. Wergin
Director, Environmental Health and Safety
University of Colorado, Boulder Campus
Stadium 180
Campus Box 375
Boulder, CO 80309-0053

AUG 12 1999

Dear Mr. Wergin:

Thank you for your August 2, 1999 letter to Mr. Delmer Billings, Chief, Standards Development, Research Special Programs Administration, in which you requested an interpretation of the applicability of the Hazardous Materials Regulations (HMR), 49 C.F.R. Parts 171-180, to six scenarios. I am responding to your request. This response addresses only Federal issues and not the possible applicability of Colorado law or regulations adopting standards similar to the Federal HMR.

In general, any person who transports hazardous material in commerce or causes hazardous material to be transported in commerce is subject to Federal hazardous material transportation law (Federal hazmat law), 49 U.S.C. §§ 5101-5127, and the HMR, 49 U.S.C. § 5103(b). A "person" includes: "a government, Indian tribe, or authority of a government or tribe offering hazardous material for transportation in commerce or transporting hazardous material to further a commercial enterprise . . ." 49 U.S.C. § 5102(9); see also 49 C.F.R. § 171.8.

Therefore, the University of Colorado (University) is not subject to the HMR as a carrier unless it transports hazardous material in commerce in furtherance of a commercial enterprise. Transportation is not in furtherance of a commercial enterprise if it is carried out: (1) by government personnel and (2) for a governmental purpose. University employees are government personnel, but contractors are not. Ownership (government or non-government) of the vehicle being used to transport the hazardous material does not affect the applicability of the HMR.

The University's transportation is not in furtherance of a commercial enterprise if it is for a governmental purpose. The scope of governmental purpose is difficult to define in the abstract. Nevertheless, an activity is likely to fall within the domain of governmental purpose when it is constitutionally mandated or authorized, when it is a traditional "sovereign" activity, when it falls within the government's police powers, or when its benefits accrue to the public as a whole. The

activity is more apt to be deemed for a non-governmental purpose if there is a conscious purpose to generate a profit or if the activity competes with, or displaces, the private sector.

Even if a contractor or other non-government employee transports a hazardous material, the HMR would only apply if the transportation is in commerce. The term "commerce" means transportation that is or affects interstate trade or traffic. 49 U.S.C. § 5102(1). Consequently, the HMR do not apply to transportation that is entirely on private property and neither follows nor crosses a public way. Property is regarded as private if public access is legally and actually restricted from the area where transportation occurs.

Applying these general principles to your scenarios leads to the following results:

Scenario 1: Do the DOT regulations apply if a University employee transports University-owned hazardous waste while driving a University vehicle solely on University roads and property which have restricted public access? Analysis: No, the HMR do not apply if the transportation does not further a commercial enterprise. The HMR do not apply to transportation by a government employee for a governmental purpose.

Scenario 2: Do the DOT regulations apply if a University employee transports University-owned hazardous waste while driving a University vehicle on unrestricted public roads? Analysis: No, the HMR do not apply if the transportation does not further a commercial enterprise. The HMR do not apply to transportation by a government employee for a governmental purpose.

Scenario 3: Do the DOT regulations apply if a non-University employee contract worker transports University-owned hazardous waste while driving a University vehicle solely on University roads and property which have restricted public access? Analysis: No, the HMR do not apply if the public is legally and actually restricted from the area where transportation occurs.

Scenario 4: Do the DOT regulations apply if a non-University employee contract worker transports University-owned hazardous waste while driving a University vehicle on unrestricted public roads? Analysis: Yes, the HMR do apply because the hazardous material is being transported by a non-government employee in an area where the public has either legal or actual access.

Scenario 5: Do the DOT regulations apply if a non-University employee contract worker transports University-owned hazardous waste while driving a non-University vehicle solely on University roads and property which have restricted public access? Analysis: No, the HMR do not apply if the public is legally and actually restricted from the area where transportation occurs.

Scenario 6: Do the DOT regulations apply if a non-University employee contract worker transports University-owned hazardous waste while driving a non-University vehicle on unrestricted public roads? Analysis: Yes, the HMR do apply because the hazardous material is being transported by a non-government employee in an area where the public has either legal or actual access.

I hope that this guidance is of assistance to you. If you need further clarification concerning this matter, please contact me.

Sincerely,



Edward H. Bonekemper, III
Assistant Chief Counsel
Hazardous Materials Safety and
Research & Technology Law

Robert Kingsley

From: Christopher Redondo
Sent: Monday, May 05, 2008 1:28 PM
To: Robert Kingsley
Subject: FW: Liquid Nitrogen Transportation

-----Original Message-----

From: Christopher Redondo
Sent: Wednesday, April 30, 2008 1:18 PM
To: Robert Kingsley
Subject: FW: Liquid Nitrogen Transportation

Bob,

FYI

-----Original Message-----

From: Jeff Christensen [mailto:ygchrist@email.arizona.edu]
Sent: Monday, April 07, 2008 11:24 AM
To: Steve Holland; Sommerfeld; 'John Little'; 'Bonnie Ferguson'; 'Jon Rousseau'
Cc: 'Ofc.LancelLines'; 'Sgt.JerryGarcia'; 'Sgt.RonSmallwood'; 'Wade Boltinghouse'; Christopher Redondo; murphjoh@u.arizona.edu
Subject: RE: Liquid Nitrogen Transportation

All:

I've been getting conflicting information on the source of the nitrogen so I will outline the scenarios and give you my understanding of the regulations.

1. The nitrogen is purchased from the Cryogenic Lab and transported to Mt Graham. The material is not in commerce and no CDL or placarding is needed. The material is going from one UA facility to another. The nitrogen could be transported to the base camp or the top of the mountain.
2. The nitrogen is purchased from a vendor and the tanks are filled at the vendor's site. The material is in commerce. A transaction has been made. The material is not leaving a UA facility and going to another. If the nitrogen is transported to the base camp or the top of the mountain it is in commerce and anything equal to or over 1001 pounds must be placarded and a CDL is required. If the nitrogen is transported to the base camp and off loaded to a staging area and then transported to the top of the mountain then the material is not in commerce and the regulations do not apply from the base camp to the top of the mountain.

I'm not trying to dictate policy but if the placarding and CDL situation is to be avoided, then getting the nitrogen from the Cryogenic lab is the way to go.

Jeff Christensen, CET, CHMM
Hazardous Waste Supervisor
Risk Management & Safety

APPENDIX K: ACTIVATING THE ERCP (GUIDELINES)

When to Contact an Incident Commander (GUIDANCE)

If an emergency situation develops at the MGIO, the discoverer (University personnel, observers or observatory staff) will immediately contact an Emergency Coordinator listed in [Appendix A](#). The primary Emergency Coordinator is to be contacted first and, if not available, a secondary Emergency Coordinator will be called (in the order listed) until someone is contacted. The first of these individuals contacted may become the Incident Commander (IC), if it is appropriate to transfer designation from the on-scene command. The Emergency Coordinators designated in Appendix A are University of Arizona personnel that can be contacted on a 24-hour basis by the numbers listed or through the UAPD Main Campus dispatch center. The UAPD dispatchers have the phone/pager numbers of all the designated primary and secondary Emergency Coordinators. There will always be at least one Emergency Coordinator that can be contacted by pager or cell phone to assume the role of the IC.

The decision to implement the Contingency Plan depends upon whether or not an imminent or actual incident could threaten human health or the environment. It is the duty of the IC to determine if the Contingency Plan is to be implemented and to direct and coordinate all activities undertaken if the Plan is implemented. As indicated in [Appendix A](#), the IC is authorized to commit the resources of The University of Arizona, as needed, to implement the Contingency Plan.

Events Leading to Implementation of the Contingency Plan

This contingency plan will be implemented in any of the following situations:

- **Medical:** A medical emergency requiring: medical care beyond basic first aid, an outside agency Emergency Medical Services (EMS) response, and/or a medical evacuation.
- **Communications Failure:** A failure of the communications system.
- **Fires:** A structural fire that cannot be immediately extinguished with available extinguishers, an explosion, or any forest fire that threatens the Observatory requiring an evacuation.
- **Large Chemical Spill and/or Release:** A spill that cannot be contained and/or cleaned up with available equipment. Any cryogenic release.
- **Power Loss:** A commercial power loss that also involves back-up generator failure.
- **Inclement Weather:** Inclement weather that traps staff at the Observatory or requires an evacuation.

Below is some additional guidance on the types of situations above:

Fire and/or Explosion

- A fire causes, or could cause, the release of significant amounts of toxic fumes.
- The fire spreads and could possibly ignite nearby fuel storage.
- The fire could possibly spread to off-site areas.
- The fire cannot be contained immediately by the use of a fire extinguisher.
- An explosion has occurred.

Spills or Material Release

- The product that has been spilled has a Threshold Limit Value (TLV) recommended by the American Conference of Governmental Industrial Hygienists of less than 10 parts per million or a reportable quantity has been reached. Reportable quantities are listed in [Appendix J](#).
- The spilled product is a hazardous material or petroleum product with the potential for ground water or surface water contamination, or is in a drainage where it could be carried off-site via surface run-off.
- The spilled product cannot be contained on-site, resulting in a potential for off-site soil contamination and/or ground or surface water pollution.
- Liquid nitrogen release inside building.

Medical Emergency

- A person has a life threatening condition.

Communications Loss

- Microwave link is damaged by lightning and communications are down/limited.

Power Loss

- Main feed is down and system fails to switch to backup generator.
- Backup generators run out of fuel.

Inclement Weather

- Snow, wind, ice, rain/flooding, etc.

APPENDIX L: INCIDENT ACTION PLAN (IAP) GUIDELINES

See FEMA Incident Action Planning Guide (if link is broken, see FEMA.GOV):
https://www.fema.gov/media-library-data/20130726-1822-25045-1815/incident_action_planning_guide_1_26_2012.pdf

Reserved.