

GALIL
DMC-2143
4-AXIS
MOTOR
CONTROLLER

GALIL
ICM-20100
DAUGHTER
BOARD #2

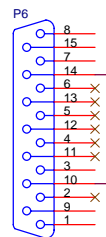
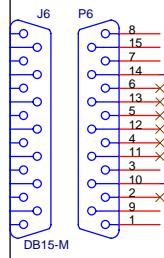
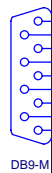
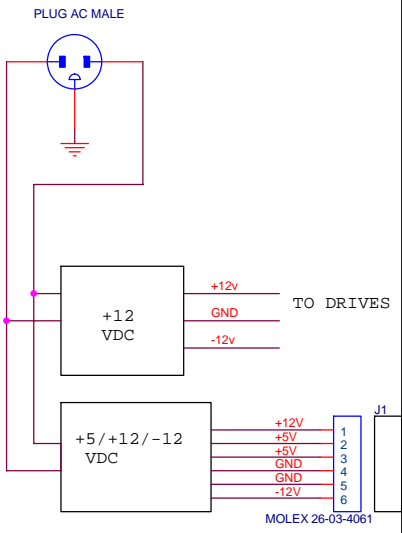

PZT 1

NOTE: FOR INITIAL TESTING ONLY ONE BNC NEEDS TO BE WIRED. IT CAN BE MOVED BETWEEN J4-J6.

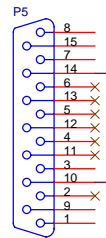
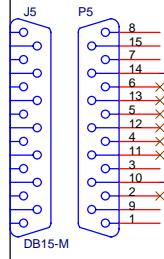

PZT 2

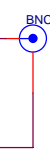
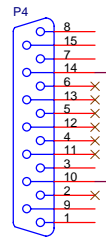
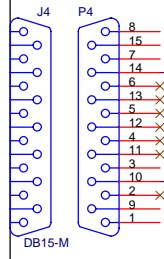

PZT 3

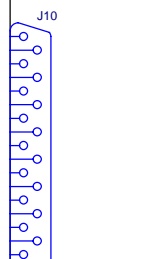
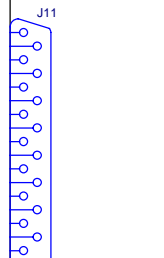
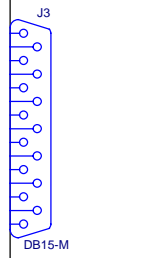

MAESTRO		
Title GALIL TEST BOARD - PZTs		
Size C	Document Number BIG61_filterwheel_eplate.pdf	Rev A
Date: Wednesday, October 06, 2004	Sheet 2	of 3