

GALIL
DMC-2143
4-AXIS
MOTOR
CONTROLLER

GALIL
ICM-20100
DAUGHTER
BOARD #1

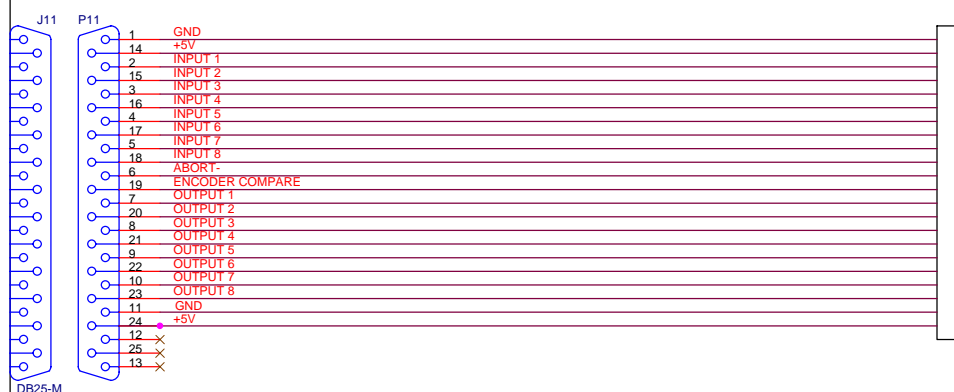
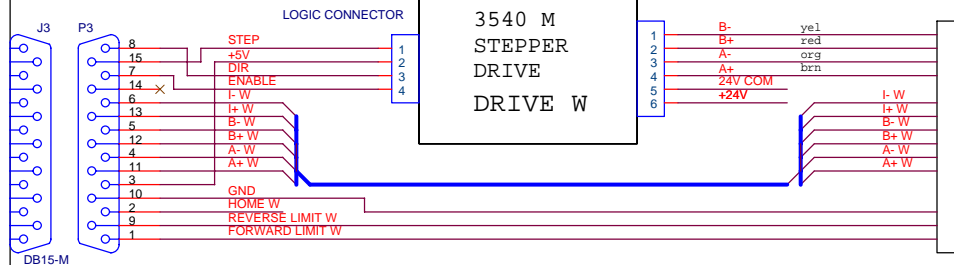
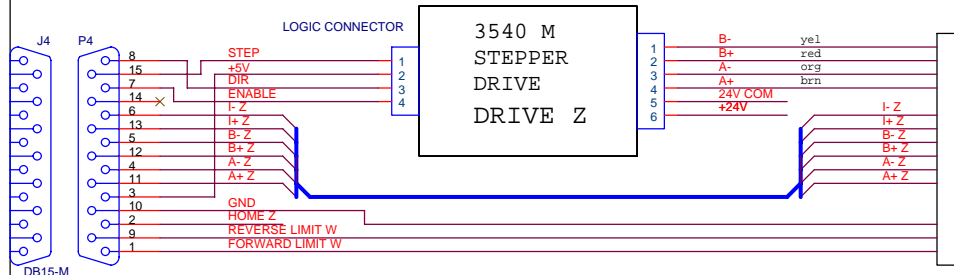
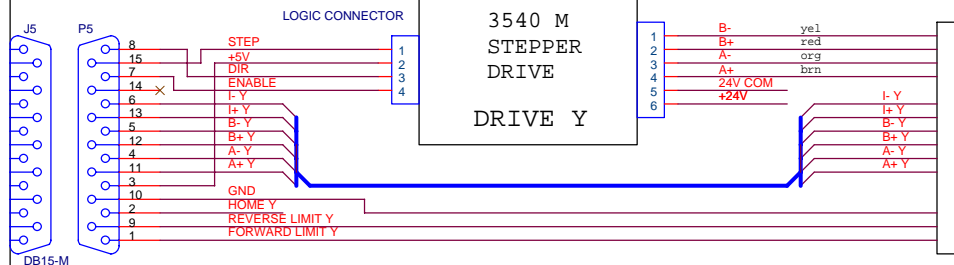
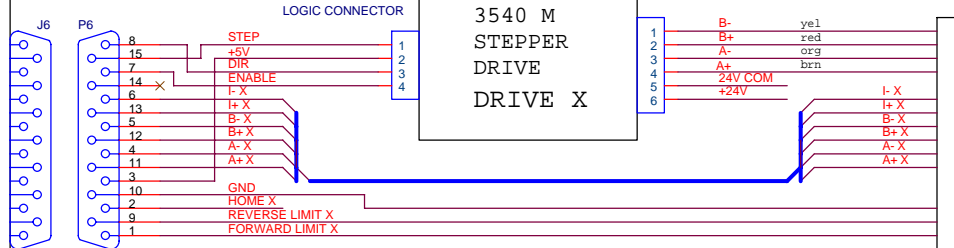
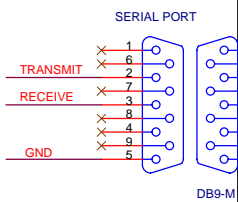
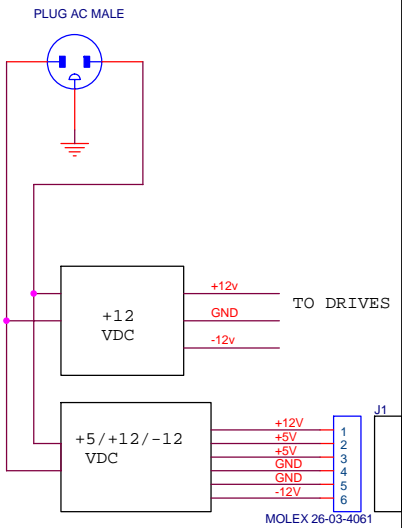

FOCUS
NOTE: FOR INITIAL TESTING ONLY ONE DRIVE NEEDS TO BE WIRED. THE INPUT CONNECTOR CAN MOVE BETWEEN J3- J5.

GRATING TILT

GUIDE CAMERA

FLIP MIRROR

LAMPS

| | | |
|--------------------------------------|---|----------|
| MAESTRO | | |
| Title GALIL TEST BOARD | | |
| Size C | Document Number BIG61_filterwheel_eplate.pdf | Rev A |
| Date: Wednesday, October 06, 2004 | Sheet 1 | of 3 |